

259000 Integrated Automation Control Sequences/Details

1.1 General Guidelines

- A. This document is designed to assist the design team in the preparation of Building Automation System documents that will accompany a full set of design documents for new construction projects, major renovation projects, and minor renovation projects on the University of Florida Campus. This document is also intended as guideline with regard to control instrumentation, preferred mechanical system concepts and general guidelines with regard to sequence of operation.

1.2 Table of Contents

TABLE OF CONTENTS	
Sheet Number	Sheet Name
IC-0.01	TABLE OF CONTENTS
IC-0.10	ADDITIONAL CONSULTANT NOTES
IC-0.20	CONTROLS ABBREVIATIONS
IC-0.30	CONTROLS LEGEND
IC-1.01D	AHU COOLING COIL CONTROL DIAGRAM
IC-1.01S	AHU COOLING COIL CONTROL SEQUENCE
IC-1.02D	AHU PREHEAT COIL CONTROL DIAGRAM
IC-1.02S	AHU PREHEAT COIL CONTROL SEQUENCE
IC-1.03D	AHU HEAT PIPE CONTROL DIAGRAM
IC-1.03S	AHU HEAT PIPE CONTROL SEQUENCE
IC-1.04	AHU AMS CONTROL DIAGRAM
IC-1.05D	AHU FAN CONTROL AND SAFETY/INTERLOCK CONTROL DIAGRAM
IC-1.05S	AHU FAN CONTROL AND SAFETY/INTERLOCK CONTROL SEQUENCE
IC-1.06D	MIXED AIR AHU CONTROL DIAGRAM
IC-1.06S	MIXED AIR AHU CONTROL SEQUENCE
IC-1.07D	AHU HUMIDIFIER CONTROL DIAGRAM
IC-1.07S	AHU HUMIDIFIER CONTROL SEQUENCE
IC-1.08D	VAV TERMINAL UNIT COOLING ONLY CONTROL DIAGRAM
IC-1.08S	VAV TERMINAL UNIT COOLING ONLY CONTROL SEQUENCE
IC-1.09D	VAV TERMINAL UNIT W/ ELECTRIC REHEAT CONTROL DIAGRAM
IC-1.09S	VAV TERMINAL UNIT W/ ELECTRIC REHEAT CONTROL SEQUENCE
IC-1.10D	VAV TERMINAL UNIT W/ HHW REHEAT CONTROL DIAGRAM
IC-1.10S	VAV TERMINAL UNIT W/ HHW REHEAT CONTROL SEQUENCE
IC-1.11D	FCU HTG/CLG CONTROL DIAGRAM
IC-1.11S	FCU HTG/CLG CONTROL SEQUENCE
IC-1.12	CONSTANT SPEED EXHAUST SINGLE FAN CONTROL DIAGRAM

TABLE OF CONTENTS	
Sheet Number	Sheet Name
IC-1.13D	EXHAUST MULTI-FAN MANIFOLD CONTROL DIAGRAM
IC-1.13S	EXHAUST MULTI-FAN MANIFOLD CONTROL SEQUENCE
IC-1.14D	LAB - SUPPLY/EXHAUST/TRACKING CONTROL DIAGRAM (BSL2 OR BSL3)
IC-1.14S	LAB - SUPPLY/EXHAUST/TRACKING CONTROL SEQUENCE (BSL2 OR BSL3)
IC-1.15D	LAB - SUPPLY/EXHAUST/FUME/TRACKING CONTROL DIAGRAM (BSL2 OR BSL3)
IC-1.15S	LAB - SUPPLY/EXHAUST/FUME/TRACKING CONTROL SEQUENCE (BSL2 OR BSL3)
IC-1.16D	CHILLED WATER BUILDING DUAL PUMPING CONTROL DIAGRAM
IC-1.16S	CHILLED WATER BUILDING DUAL PUMPING CONTROL SEQUENCE
IC-1.17	UTILITY METER OPTION - ONICON
IC-1.18	UTILITY METER OPTION - FLEXIM
IC-1.19D	PROCESS CHILLED WATER SYSTEM CONTROL DIAGRAM
IC-1.19S	PROCESS CHILLED WATER SYSTEM CONTROL SEQUENCE
IC-1.20D	STEAM HEAT EXCHANGER CONTROL DIAGRAM
IC-1.21D	HOT WATER REDUNDANT HEAT EXCHANGER CONTROL DIAGRAM
IC-1.21S	STEAM/HOT WATER REDUNDANT HEAT EXCHANGER CONTROL SEQUENCE
IC-1.22D	HHW BOILER CONTROL DIAGRAM
IC-1.22S	HHW BOILER CONTROL SEQUENCE
IC-1.23D	AIR COOLED CHILLER CONTROL DIAGRAM
IC-1.23S	AIR COOLED CHILLER CONTROL SEQUENCE
IC-1.24D	CHILLED BEAM WATER SUPPLY CONTROL DIAGRAM
IC-1.24S	CHILLED BEAM WATER SUPPLY CONTROL SEQUENCE
IC-1.25D	VENTILATION BOX W/ HOT WATER REHEAT AND MULTIZONE CHILLED BEAM - TYPE 1
IC-1.25S	CHILLED BEAM CONTROL SEQUENCE
IC-1.26D	ENERGY RECOVERY HEAT WHEEL CONTROL DIAGRAM
IC-1.26S	ENERGY RECOVERY HEAT WHEEL CONTROL SEQUENCE
IC-1.27	DIFFERENTIAL PRESSURE DETAIL













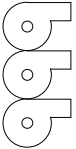
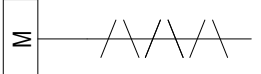

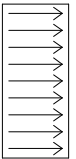
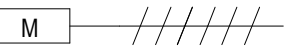



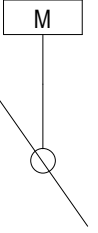

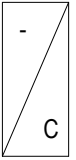
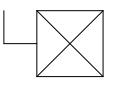

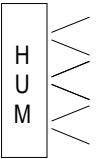



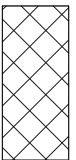



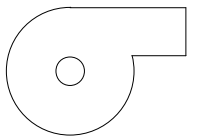
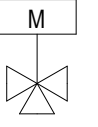

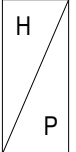
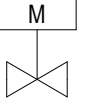

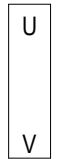



ADDITIONAL NOTES

1. THESE DRAWINGS ARE INTENDED TO PROVIDE THE CONSULTANT WITH A BASIC GUIDELINE OF CONTROL SYSTEM DESIGN INTENT AND TO A CERTAIN EXTENT, THE PREFERRED MECHANICAL COMPONENTS. THESE CONTROL DRAWINGS SHALL BE REVIEWED AND EDITED BY THE CONSULTANT TO MATCH THE REQUIREMENTS OF THE PROJECT. THE FINAL USE OF THESE DRAWINGS AND IMPLEMENTATION SHALL BE THE SOLE RESPONSIBILITY OF THE ENGINEER OF RECORD.
2. FOR ALL RENOVATION WORK THAT REQUIRES TIE-IN TO EXISTING BAS, CONTROL VENDOR MUST PROVIDE A PRE-DESIGN SYSTEM AUDIT. SYSTEM AUDIT WILL INDICATE CURRENT BUILDING LEVEL CONTROLLER CAPACITY AND PROVIDE AN ESTIMATION OF CAPACITY AFTER DESIGN IMPLEMENTATION. IF REQUIRED CONTROLLER CAPACITY EXCEEDS EXISTING CAPACITY THEN A NEW BUILDING LEVEL CONTROLLER WILL BE REQUIRED. SYSTEM AUDIT AND RECOMMENDATIONS ARE TO BE SUBMITTED TO UF FACILITY SERVICES FOR REVIEW AND FINAL APPROVAL.
3. ALL HIGH STATIC PRESSURE SENSORS TO BE SET NO GREATER THAN DAMPER AND DUCTWORK PRESSURE RATING.
4. CONTROL VALUE SETPOINTS SHALL BE MANUALLY ADJUSTABLE OVER THEIR ENTIRE CONTROL RANGE. SETPOINTS MAY BE FACTORY SET, BUT SHALL BE FIELD ADJUSTABLE. SPECIFIED SETPOINTS SHALL TAKE PRECEDENCE OVER FACTORY SETTINGS.
5. WHERE THE CONTROL SEQUENCES INDICATES AN AUTOMATIC RESET PROCEDURE, THE BAS SHALL INDICATE THE CURRENT VALUE AND MINIMUM/MAXIMUM SETTINGS.
6. WHERE MULTIPLE SENSORS ARE USED, ANALYSIS FOR THESE SENSORS SHALL BE ONE OF THE FOLLOWING AS REQUIRED:
 - a. (A) AVERAGE: THE AVERAGE VALUE OF THE SENSOR OUTPUTS SHALL BE USED AS THE CONTROL SIGNAL.
 - b. (MAX) MAXIMUM DEMAND: THE SENSOR INDICATING THE MAXIMUM DEMAND SHALL BE USED FOR CONTROL. SHOULD THE OUTPUT SIGNAL OF ANOTHER SENSOR INDICATE THAT IT HAS THE MAXIMUM DEMAND, CONTROL SHALL BE SHIFTED TO THAT SENSOR.
 - c. (MIN) MINIMUM DEMAND: THE SENSOR INDICATING THE MINIMUM DEMAND SHALL BE USED FOR CONTROL. SHOULD THE OUTPUT SIGNAL OF ANOTHER SENSOR INDICATE THAT IT HAS THE MINIMUM DEMAND, CONTROL SHALL BE SHIFTED TO THAT SENSOR.
7. HAND-OFF-AUTOMATIC SWITCHES (HOA) SHALL HAVE THEIR OPERATING POSITION MONITORED. SHOULD THE CONTROLLING DEVICE BE INDEXED TO THE HAND POSITION, AN ALARM SHOULD INDICATE THE UNIT IDENTIFICATION, THE TIME, AND THE MESSAGE "IN THE MANUAL ON POSITION."
8. BAS SHALL PROVIDE TIME DELAYS DURING RESTART OF EMERGENCY POWER AND RESTORATION OF NORMAL POWER SO THAT ALL EQUIPMENT DOES NOT ATTEMPT TO START AT THE SAME TIME.
9. LOCATE THERMOSTATS AND OTHER DEVICES REQUIRING OCCUPANCY MONITORING OR ADJUSTMENT AT AN ELEVATION 4'-0" ABOVE FINISHED FLOOR, IN ACCORDANCE WITH ADA REGULATIONS.
10. CEILING ACCESS PANELS AND DUCT ACCESS PANELS SHALL BE PROVIDED WHERE REQUIRED, TO SERVICE CONTROLLERS, DAMPERS, HEATERS, VALVES, AND OTHER CONCEALED EQUIPMENT.
11. ALL VALVE AND DAMPER OPERATORS SHALL BE ELECTRONIC TYPE UNDER DIRECT DIGITAL CONTROL. USE OF PNEUMATIC ACTIVATION SHALL BE APPROVED BY FACILITY SERVICES.
12. VARIABLE FREQUENCY DRIVES SHALL INTERFACE WITH THE BAS AS SPECIFIED WITHIN THE SPECIFICATIONS AND INCLUDE ALL INPUT, OUTPUT, AND ALARM DATA.
13. FOR ANY ADJUSTMENTS MADE TO THE BUILDING AUTOMATION SYSTEMS, THE CONTROLLER DEFAULT VALUES SHALL MATCH THE FINAL FIELD ADJUSTED SETTINGS.
14. ALL INSTRUMENTATION ASSOCIATED WITH A SPECIFIC SYSTEM AND CONTROL LOOP SHALL BE CONNECTED TO THE ASSOCIATED CONTROLLER AND SHALL NOT BE CONNECTED TO REMOTE CONTROLLER. THIS IS TO ENSURE STANDALONE OPERATION.

CONTROLS ABBREVIATIONS

AFF	ABOVE FINISHED FLOOR	FC	FAIL CLOSE UPON LOSS OF POWER SOURCE	PCWR	PROCESS COOLING WATER RETURN
AHU	AIR HANDLING UNIT	FCU	FAN COIL UNIT	PCWS	PROCESS COOLING WATER SUPPLY
AI	ANALOG INPUT	FEV	FUME EXHAUST VALVE	PRV	PRESSURE REDUCING VALVE
AO	ANALOG OUTPUT	FM	FLOW METER	PS	PRESSURE SENSOR
BAS	BUILDING AUTOMATION SYSTEM	FMS	FLOW MEASURING STATION	PSI	POUNDS PER SQUARE INCH
BLU	BUILDING LEVEL CONTROLLER	FO	FAIL OPEN UPON LOSS OF POWER SOURCE	RA	RETURN AIR
BTU	BRITISH THERMAL UNIT	FS	FLOAT SWITCH	RH	RELATIVE HUMIDITY
CBWR	CHILLED BEAM WATER RETURN	FT	FEET	RHC	REHEAT COIL
CBWS	CHILLED BEAM WATER SUPPLY	FTL	FAIL TO LAST POSITION UPON LOSS OF POWER SOURCE	RPM	REVOLUTIONS PER MINUTE
CFM	CUBIC FEET PER MINUTE	FTU	FAN TERMINAL UNIT	RR	RETURN AIR REGISTER
CH	CHILLER	FZ	FREEZESTAT	RV	ROOF VENT
CHW	CHILLED WATER	GEV	GENERAL EXHAUST VALVE	SA	SUPPLY AIR
CHWP	CHILLED WATER PUMP	GPM	GALLONS PER MINUTE	SCR	SILICON CONTROLLED RECTIFIER
CHWR	CHILLED WATER RETURN	H	HUMIDISTAT	SD	SMOKE DAMPER
CHWS	CHILLED WATER SUPPLY	HHW	HEATING HOT WATER	SF	SQUARE FEET; SUPPLY FAN
CO	CLEANOUT	HHWP	HEATING HOT WATER PUMP	SP	STATIC PRESSURE
CO2	CARBON DIOXIDE	HHWR	HEATING HOT WATER RETURN	SV	SUPPLY VALVE
COMM	COMMUNICATION	HHWS	HEATING HOT WATER SUPPLY	T	THERMOSTAT
COND	CONDENSATE	HS	HUMIDITY SENSOR	TS	TEMPERATURE SENSOR
CSR	CURRENT SENSING RELAY	HX	HEAT EXCHANGER	TX	TRANSFORMER
DDC	DIRECT DIGITAL CONTROLS	IN.	INCHES	TYP	TYPICAL
DI	DIGITAL INPUT	IN. WG	INCHES OF WATER, GAUGE	UV	ULTRAVIOLET
DO	DIGITAL OUTPUT	KW	KILOWATTS	VAV	VARIABLE AIR VOLUME
DP	DIFFERENTIAL PRESSURE	KWH	KILOWATT HOUR	VFD	VARIABLE FREQUENCY DRIVE
EA	EACH	LL	LOW LIMIT	WDS	WATER DETECTION SENSOR
EBMS	ENTERPRISE BUILDING MANAGEMENT SYSTEM	MA	MIXED AIR		
EDH	ELECTRIC DUCT HEATER	MD	MOTORIZED DAMPER		
EF	EXHAUST FAN	MIN	MINUTE; MINIMUM		
EH	ELECTRIC HEAT	NC	NORMALLY CLOSED UPON LOSS OF CONTROL SIGNAL		
EOR	ENGINEER OF RECORD	NO	NORMALLY OPEN UPON LOSS OF CONTROL SIGNAL		
ES	END SWITCH	NTS	NOT TO SCALE		
EV	EXHAUST VALVE	OA	OUTDOOR AIR		
EXH	EXHAUST	OS	OCCUPANCY SENSOR		
°F	DEGREES FAHRENHEIT	P	PUMP		
F/A	FIRE ALARM	PCW	PROCESS COOLING WATER		
FACP	FIRE ALARM CONTROL PANEL	PCWP	PROCESS COOLING WATER PUMP		

CONTROLS LEGEND

	AIR MONITORING SENSOR		LOW LIMIT SAFETY (FREEZESTAT)		AHU FAN ARRAY - SEE AHU SCHEDULE FOR QUANTITY		MOTORIZED OPPOSED BLADE DAMPER
	ANALOG INPUT		LOW PRESSURE LIMIT		AIR FLOW MONITORING STATION		MOTORIZED PARALLEL BLADE DAMPER
	ANALOG OUTPUT		LOW PRESSURE SAFETY		CHECK VALVE		MOTORIZED VOLUME CONTROL DAMPER
	BAS COMMUNICATION LINK		MOTORIZED ACTUATOR (ELECTRIC)		COIL (C - COOLING; H - HEATING HOT WATER; EH - ELECTRIC HEATING)		STARTER
	CARBON DIOXIDE SENSOR		PRESSURE SENSOR		DUCT HUMIDIFIER		TEMPERATURE SENSOR (AVERAGING)
	CONDENSATE LEVEL ALARM		SILICON CONTROLLED RECTIFIER		FILTER BANK		TEMPERATURE SENSOR (POINT)
	CONDENSATION MONITOR		STATIC PRESSURE SENSOR		FAN		THREE WAY CONTROL VALVE
	CURRENT SENSING RELAY		TEMPERATURE SENSOR		HEAT PIPE		TWO WAY CONTROL VALVE
	DAMPER END SWITCH		THERMOSTAT WITH LOCAL ADJUSTMENT		ULTRAVIOLET LIGHT		VARIABLE FREQUENCY DRIVE
	DIFFERENTIAL PRESSURE TRANSMITTER / SWITCH		VARIABLE FREQUENCY DRIVE				
	DIGITAL INPUT		WATER DETECTION SENSOR				
	DIGITAL OUTPUT						
	DUCT SMOKE DETECTOR (BY DIV 16)						
	FLOAT SWITCH						
	FLUID FLOW METER						
	HARDWIRE INTERLOCK						
	HIGH PRESSURE LIMIT						
	HUMIDITY HIGH LIMIT						
	HUMIDITY SENSOR						

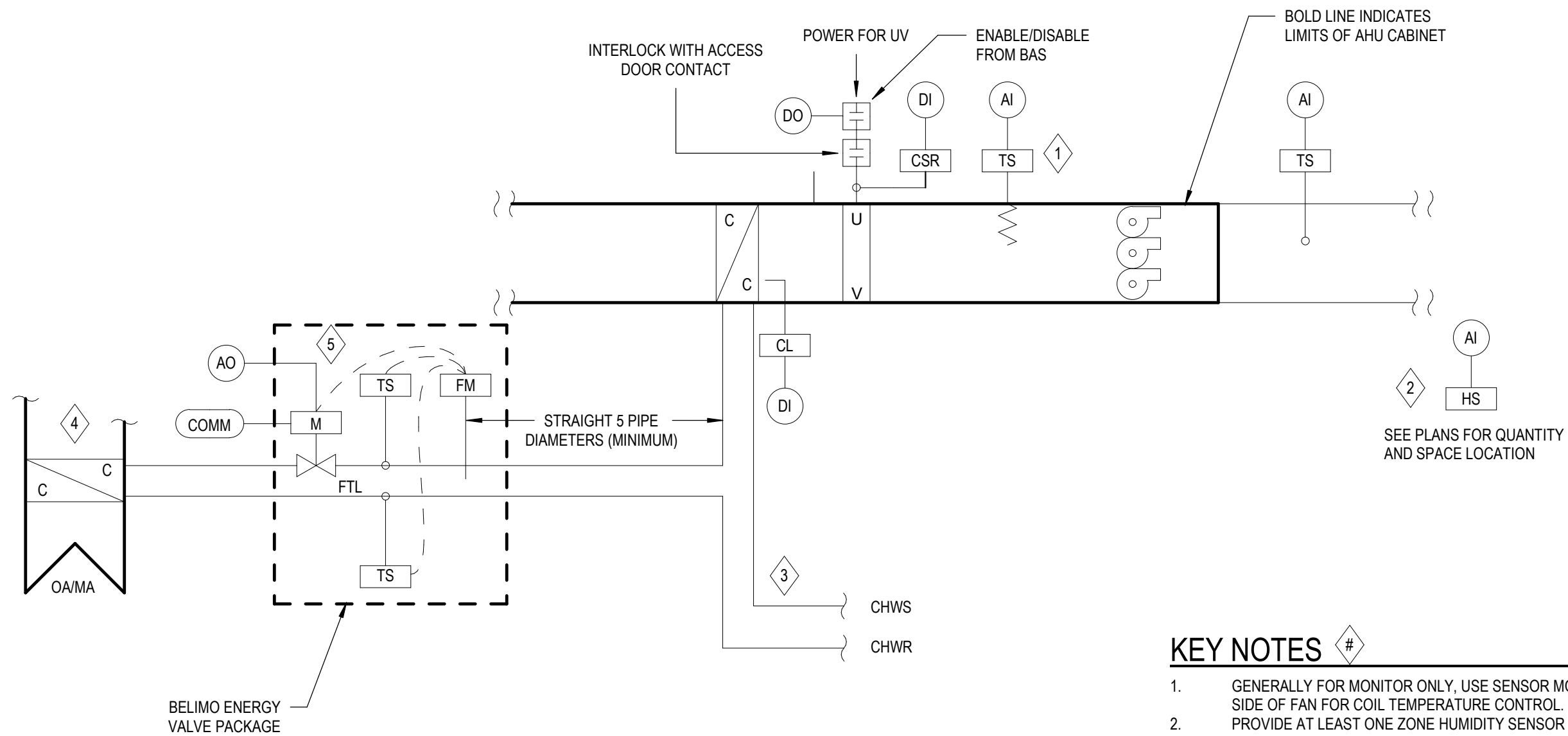

KEY NOTES

1. GENERALLY FOR MONITOR ONLY, USE SENSOR MOUNTED ON DISCHARGE SIDE OF FAN FOR COIL TEMPERATURE CONTROL.
2. PROVIDE AT LEAST ONE ZONE HUMIDITY SENSOR FOR EACH AHU.
3. AREAS REQUIRING FAIL TO OPEN (F.O.) INCLUDE TELECOMM ROOMS, ELEVATOR EQUIPMENT ROOMS, LABORATORY EQUIPMENT ROOMS (FREEZER ROOM), AND ELECTRIC ROOMS.
4. CONSIDER PRE COOL COILS WHENEVER POSSIBLE TO IMPROVE DELTA T OF SYSTEM. CONSIDER FREEZE PROTECTION OF COIL WHERE APPLICABLE.
5. UF STANDARD SHALL BE THE BELIMO ENERGY VALVE FOR ALL AIR HANDLING UNIT APPLICATIONS. GENERALLY UNITS EXCEEDING 2,000 CFM.

AHU COOLING COIL CONTROL SEQUENCE GUIDELINES (IC-1.01S)

NOTES TO THE ENGINEER:

1. THIS SEQUENCE GUIDE IS INTENDED TO PROVIDE THE DESIGN PROFESSIONAL WITH A BASIC GUIDELINE OF MINIMUM REQUIREMENTS FOR A TYPICAL COOLING COIL CONTROL. ALL PROPOSED MODIFICATIONS SHALL BE REVIEWED WITH UF FACILITY SERVICES (FS).
2. THE INTENT IS FOR THIS SEQUENCE TO BE INCLUDED IN THE CONTRACT DRAWINGS ALONG WITH THE CONTROL DIAGRAMS.
3. REFERENCE STANDARD CONTROL DIAGRAM IC-1.01D

PROVIDE THE FOLLOWING FOR AIR HANDLING UNIT.

1. COOLING COIL CONTROL

SAFETY CONTROL SEQUENCES: PROVIDE THE FOLLOWING SAFETY FUNCTIONS. ALL SAFETIES SHALL BE OPERATIONAL REGARDLESS OF FAN MODE (HAND, OFF, AUTO, OR BYPASS)

1. CONDENSATE LEVEL ALARM: UPON INDICATION OF A HIGH LEVEL ALARM, CLOSE CHILLED WATER VALVE AND INITIATE BAS ALARM.
2. UV LIGHT ACCESS DOOR SHALL INCLUDE A SAFETY SWITCH THAT DISCONNECTS UV LIGHT POWER WHENEVER THE DOOR IS OPEN.

NOTE: WHEN SERVING ANIMAL SPACES, THE COOLING/HEATING/FAN MODE SHALL REMAIN ACTIVE.

START-STOP SEQUENCES: PROVIDE THE FOLLOWING OPERATIONAL AND INTERLOCK FUNCTIONS WHEN THE AIR HANDLING UNIT FAN IS STARTED or STOPPED, UNLESS OTHERWISE NOTED. THESE SEQUENCES SHALL BE OPERATIONAL UPON PROOF OF FAN STATUS REGARDLESS OF MODE (HAND, OFF, AUTO, OR BYPASS)

1. COOLING COIL CONTROL VALVE: ENABLE COIL CONTROL UPON PROOF OF FAN START. CLOSE VALVE TO COIL UPON PROOF OF FAN STOP.
2. UV LAMPS: ENABLE UV LAMPS ON SUPPLY FAN(S) START. PROVIDE INTERLOCK TO DISABLE UV LAMP WHEN AHU ACCESS DOOR IS OPEN. DISABLE UV LAMPS ON FAN STOP. INCLUDE A SCHEDULE PROGRAM THAT ALLOWS THE OPERATOR TO SCHEDULE RUNTIME OF UV LIGHT.

WHEN THE UNIT IS PROVEN ON IN RESPONSE TO THE BAS OR A MANUAL OVERRIDE, PROVIDE THE FOLLOWING.

COOLING COIL CONTROL: BAS SHALL MODULATE THE COOLING COIL CONTROL VALVE AS REQUIRED TO MAINTAIN SUPPLY AIR DISCHARGE AIR TEMPERATURE (AS SENSED DOWNSTREAM OF FAN) CALCULATED SET-POINT AS DETERMINED BY SUPPLY AIR RESET SEQUENCE.

SUPPLY AIR TEMPERATURE RESET: THE BAS SHALL CONTINUOUSLY POLL ALL AIR TERMINAL UNITS TO ESTABLISH THE NUMBER OF HEATING AND COOLING REQUEST. ONCE EVERY 15 MINUTES (ADJ), THE TOTAL QUANTITY OF HEATING AND COOLING REQUESTS SHALL BE CALCULATED AS A PERCENTAGE OF ALL BOXES SERVED BY ASSOCIATED AHU. THE SUPPLY AIR RESET CONDITIONS AND PARAMETERS SHALL BE ESTABLISHED BY EOR.

HUMIDITY OVERRIDE: THE BAS SHALL CONTINUE MONITOR SPACE HUMIDITY CONDITIONS USING A HIGH SELECT STRATEGY. IN THE EVENT THE HUMIDITY LEVELS EXCEED THE HIGH LIMIT, THE UNIT SHALL ENTER A DEHUMIDIFICATION MODE. ALL SCHEMES SHALL INCLUDE CONDITIONS TO ENTER AND EXIT DEHUMIDIFICATION MODE. RESET CONDITIONS AND PARAMETERS SHALL BE ESTABLISHED BY EOR.

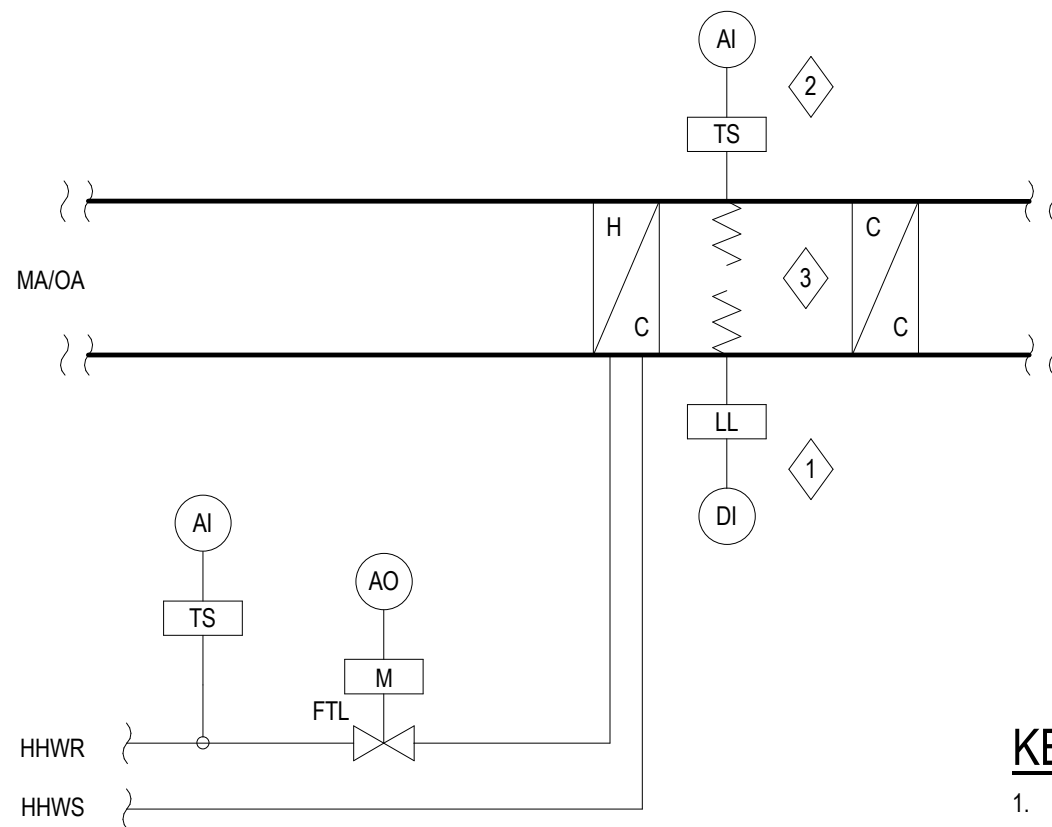

KEY NOTES #

1. LOW LIMIT (FREEZE PROTECTION) TO BE MONITORED BY BAS AND SHALL NOT SHUT DOWN UNIT. ACTIVATION OF LOW LIMIT DEVICE SHALL CAUSE BAS TO FORCE OPEN ALL COIL VALVES AND SLOW FAN TO 50%.
2. PREHEAT COILS SHALL BE CONTROLLED DIRECTLY BY PREHEAT SENSOR AND NOT BE SEQUENCED WITH COOLING COIL.
3. ENSURE ADEQUATE COVERAGE OF ENTIRE COIL. THIS MAY REQUIRE LONGER SENSORS OR MULTIPLE SENSORS.

AHU PREHEAT COIL CONTROL SEQUENCE GUIDELINES (IC-1.02S)

NOTES TO THE ENGINEER:

1. THIS SEQUENCE GUIDE IS INTENDED TO PROVIDE THE DESIGN PROFESSIONAL WITH A BASIC GUIDELINE OF MINIMUM REQUIREMENTS FOR A TYPICAL PREHEAT COIL CONTROL. ALL PROPOSED MODIFICATIONS SHALL BE REVIEWED WITH UF FACILITY SERVICES (FS).
2. THE INTENT IS FOR THIS SEQUENCE TO BE INCLUDED IN THE CONTRACT DRAWINGS ALONG WITH THE CONTROL DIAGRAMS.
3. REFERENCE STANDARD CONTROL DIAGRAM IC-1.02D

PROVIDE THE FOLLOWING FOR AIR HANDLING UNIT.

1. PREHEAT COIL CONTROL

SAFETY CONTROL SEQUENCES: PROVIDE THE FOLLOWING SAFETY FUNCTIONS. ALL SAFETIES SHALL BE OPERATIONAL REGARDLESS OF FAN MODE (HAND, OFF, AUTO, OR BYPASS)

1. LOW LIMIT (FREEZE PROTECTION): UTILIZE THE LIMIT TEMPERATURE SENSOR (FREEZE STAT) SERPENTINED ACROSS THE LEAVING SIDE OF THE PRE-HEAT COIL. WHEN THE TEMPERATURE FALLS TO 38 DEG F (ADJ):
 - a. OVERRIDE ALL WATER COILS TO 50% OPEN POSITION
 - b. REDUCE FAN SPEED TO 50% OF FULL SPEED
 - c. SEND A LOW LIMIT ALARM TO THE BAS
2. IN THE EVENT THE LOW LIMIT (FREEZE PROTECTION) ALARM IS ACTIVATED AND THE HEATING HOT WATER PUMP IS CONFIRMED OFF, SHUTDOWN AHU FAN AND FORCE ALL COIL VALVES TO THEIR 100% OPEN CONDITION.

START-STOP SEQUENCES: PROVIDE THE FOLLOWING OPERATIONAL AND INTERLOCK FUNCTIONS WHEN THE AIR HANDLING UNIT FAN IS STARTED or STOPPED, UNLESS OTHERWISE NOTED. THESE SEQUENCES SHALL BE OPERATIONAL UPON PROOF OF FAN STATUS REGARDLESS OF MODE (HAND, OFF, AUTO, OR BYPASS)

1. PRE-HEATING COIL CONTROL VALVE: ENABLE COIL CONTROL VALVE UPON PROOF OF FAN START. CLOSE VALVE TO COIL UPON PROOF OF FAN STOP.

WHEN THE UNIT IS PROVEN ON IN RESPONSE TO THE BAS OR A MANUAL OVERRIDE, PROVIDE THE FOLLOWING.

PREHEAT COIL CONTROL: BAS SHALL MODULATE THE PREHEAT COIL CONTROL VALVE AS REQUIRED TO MAINTAIN PREHEAT AIR TEMPERATURE (AS SENSED IMMEDIATELY DOWNSTREAM OF PREHEAT COIL). PREHEAT CONTROL SHALL BE INDEPENDENT OF COOLING COIL WITH NO LOGIC TO PREVENT SIMULTANEOUS HEATING AND COOLING. THIS IS HANDLED BY DESIGNATING SETPOINTS THAT WON'T ALLOW FOR SIMULTANEOUS HEATING AND COOLING.

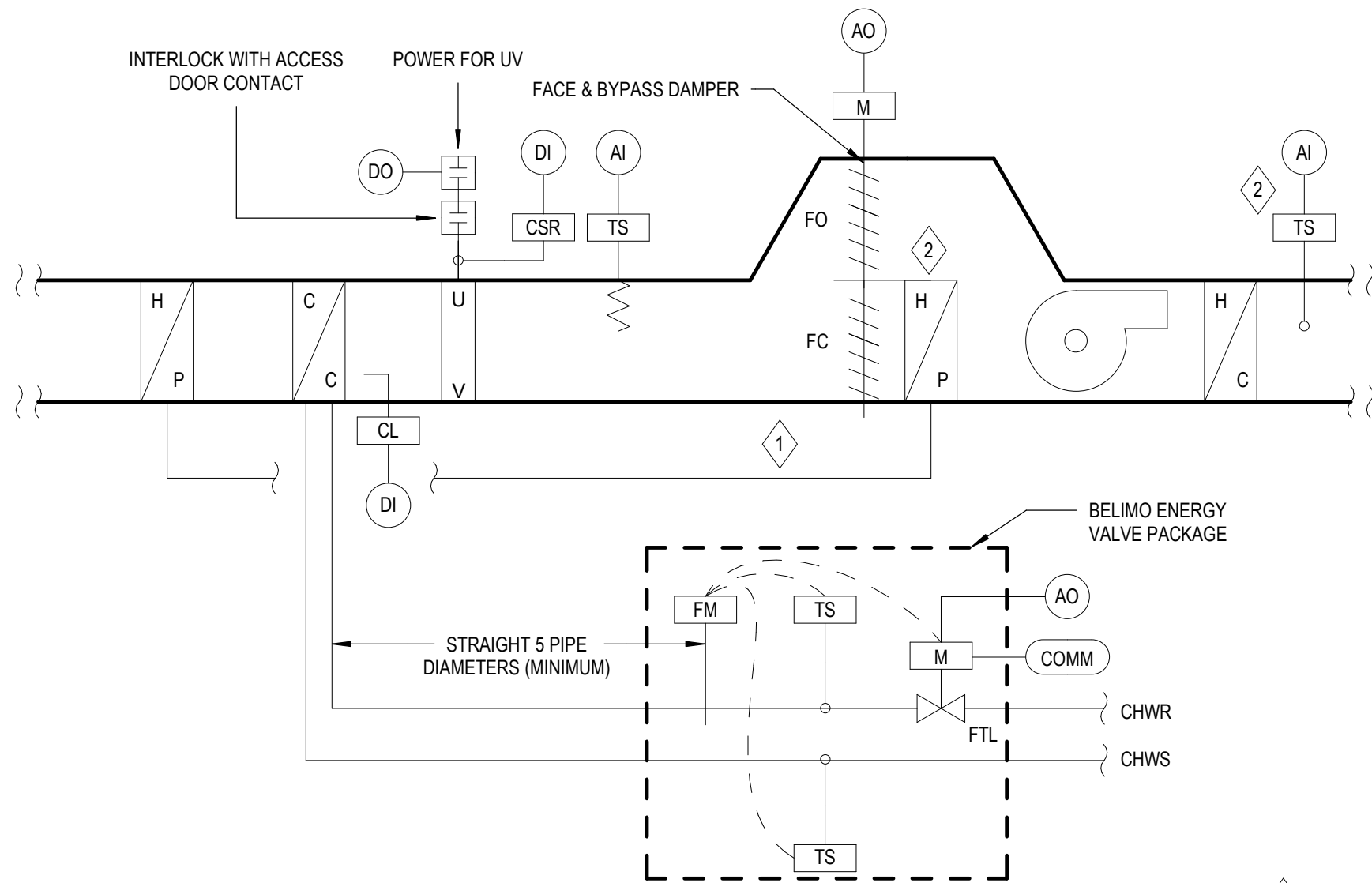

KEY NOTES #

1. HEAT PIPE TO BE CONSTANT FLOW WITH NO VARIABLE FLOW CAPABILITY.
2. FINAL DISCHARGE TEMPERATURE SHALL BE CONTROLLED WITH HEAT PIPE BYPASS AND REHEAT COIL OPERATING IN SEQUENCE.
3. ENSURE ACCESSIBILITY OF COILS TO ALLOW FOR SERVICE AND CLEANING.

AHU HEAT PIPE CONTROL SEQUENCE GUIDELINES (IC-1.03S)

NOTES TO THE ENGINEER:

1. THIS SEQUENCE GUIDE IS INTENDED TO PROVIDE THE DESIGN PROFESSIONAL WITH A BASIC GUIDELINE OF MINIMUM REQUIREMENTS FOR A TYPICAL WRAP AROUND HEAT PIPE CONTROL. ALL PROPOSED MODIFICATIONS SHALL BE REVIEWED WITH UF FACILITY SERVICES (FS).
2. THE INTENT IS FOR THIS SEQUENCE TO BE INCLUDED IN THE CONTRACT DRAWINGS ALONG WITH THE CONTROL DIAGRAMS.
3. REFERENCE STANDARD CONTROL DIAGRAM IC-1.03D

PROVIDE THE FOLLOWING FOR WRAP AROUND HEAT PIPE UNIT.

1. HEAT PIPE FACE AND BYPASS DAMPER CONTROL

START-STOP SEQUENCES: PROVIDE THE FOLLOWING OPERATIONAL AND INTERLOCK FUNCTIONS WHEN THE AIR HANDLING UNIT FAN IS STARTED or STOPPED, UNLESS OTHERWISE NOTED. THESE SEQUENCES SHALL BE OPERATIONAL UPON PROOF OF FAN STATUS REGARDLESS OF MODE (HAND, OFF, AUTO, OR BYPASS)

1. HEAT PIPE BYPASS: ENABLE HEAT PIPE CONTROL UPON PROOF OF FAN START. OPEN HEAT PIPE BYPASS DAMPER TO FULL BYPASS UPON PROOF OF FAN STOP.
2. REHEAT COIL CONTROL: ENABLE REHEAT CONTROL UPON PROOF OF FAN START. DISABLE CONTROL AND CLOSE REHEAT COIL UPON PROOF OF FAN STOP.

WHEN THE UNIT IS PROVEN ON IN RESPONSE TO THE BAS OR A MANUAL OVERRIDE, PROVIDE THE FOLLOWING.

HEAT PIPE COIL CONTROL: THE BAS SHALL MODULATE THE HEAT PIPE BYPASS DAMPER AS REQUIRED TO MAINTAIN A CALCULATED SUPPLY AIR TEMPERATURE (AS SENSED DOWNSTREAM OF REHEAT COIL). THE SUPPLY AIR SETPOINT SHALL BE ESTABLISHED USING THE FOLLOWING RESET STRATEGY:

REHEAT COIL CONTROL: THE REHEAT COIL SHALL BE USED TO SUPPLEMENT THE HEATPIPE WHEN CONDITIONS LIMIT FINAL STAGE HEAT PIPE COIL CAPACITY (I.E. LOWER ENTERING AIR CONDITIONS AT THE FIRST STAGE COIL).

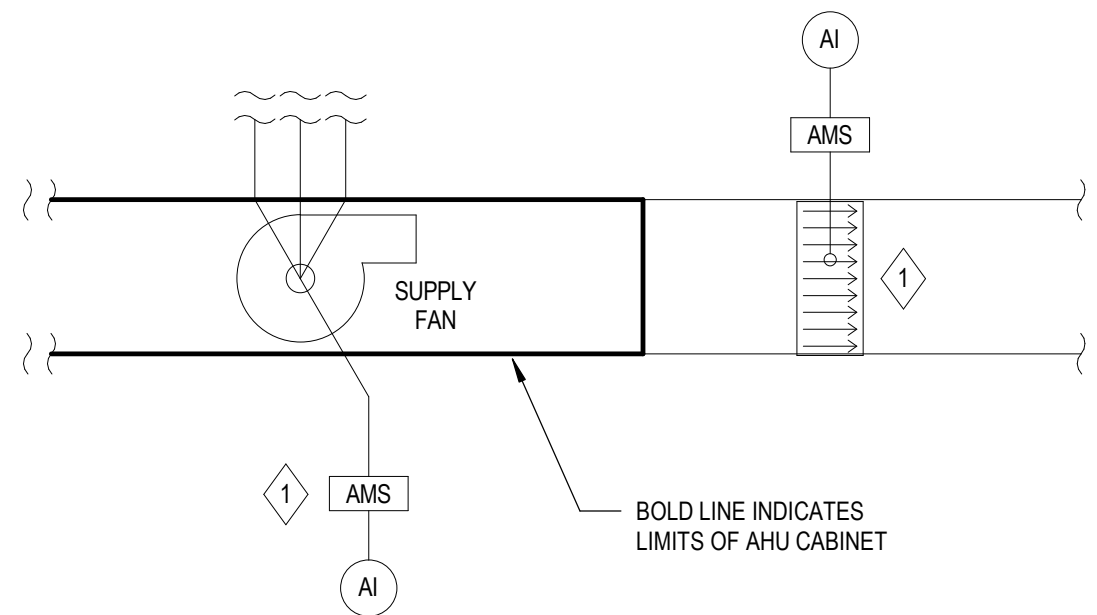

KEY NOTES

1. AIR MONITOR STATION MAY BE SPECIFIED WITH AHU FANS OR DUCT MOUNTED. ENGINEER OF RECORD TO SELECT. UF PREFERENCE IS TO USE DUCT MOUNTED AIR FLOW STATIONS WHEN POSSIBLE FOR BETTER ACCURACY.

KEY NOTES

1. FAN ARRAY MAY INCLUDE REDUNDANT DRIVE PACKAGE OR MULTIPLE VFD PER FAN PACKAGE (FULL SIZE OR MINI DRIVES). LIMIT SHALL BE FOUR FANS WHEN USING FULL SIZE DRIVES, OTHERWISE USE REDUNDANT DRIVE PACKAGE OR MINI DRIVE. ALL CONTROL SIGNALS AND SAFETIES SHALL BE REVISED AS NEEDED.
2. STATUS SHALL BE PROVIDED FOR EACH FAN IN ARRAY WHEN APPLICABLE.
3. PRESSURE SAFETY DEVICES SHALL BE MANUAL RESET.
4. ISOLATION DAMPERS ARE TO BE HARDWIRED TO FAN TO ENSURE OPERATION WHEN CONTROLLER IS OFFLINE.
5. DAMPER PROOF (ES) SHALL BE VIA DIRECT COUPLED PROVING DEVICE AND NOT UTILIZE DAMPER ACTUATOR FEEDBACK CONTACT POINT.
6. OA DAMPER INTERLOCK ONLY REQUIRED IF UNIT IS 100% OA.

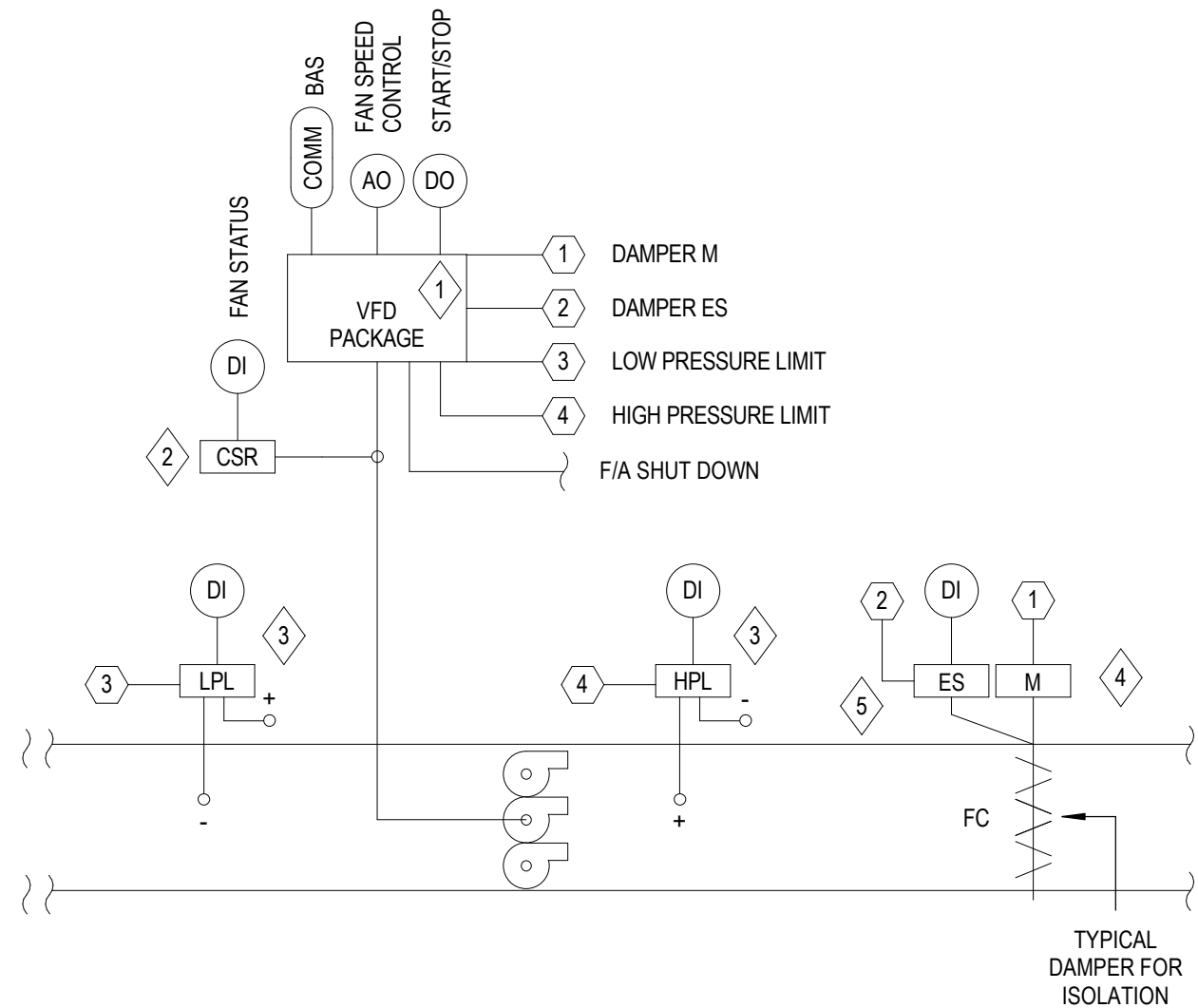
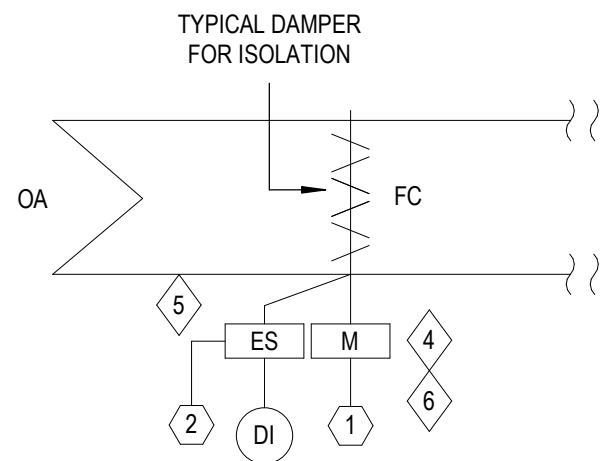

AHU FAN CONTROL AND SAFETY/INTERLOCK CONTROL SEQUENCE GUIDELINES (IC-1.05S)

NOTES TO THE ENGINEER:

1. THIS SEQUENCE GUIDE IS INTENDED TO PROVIDE THE DESIGN PROFESSIONAL WITH A BASIC GUIDELINE OF MINIMUM REQUIREMENTS FOR A TYPICAL FAN AND SAFETY INTERLOCK CONTROL. ALL PROPOSED MODIFICATIONS SHALL BE REVIEWED WITH UF FACILITY SERVICES (FS).
2. THE INTENT IS FOR THIS SEQUENCE TO BE INCLUDED IN THE CONTRACT DRAWINGS ALONG WITH THE CONTROL DIAGRAMS.
3. REFERENCE STANDARD CONTROL DIAGRAM IC-1.05D

PROVIDE THE FOLLOWING FOR AIR HANDLING UNIT.

1. VARIABLE FREQUENCY DRIVE WITH STATIC PRESSURE CONTROL
2. ISOLATION DAMPER CONTROL

SAFETY CONTROL SEQUENCES: PROVIDE THE FOLLOWING SAFETY FUNCTIONS. ALL SAFETIES SHALL BE OPERATIONAL REGARDLESS OF FAN MODE (HAND, OFF, AUTO, OR BYPASS)

1. ANY DAMPER THAT CAN RESULT IN ISOLATION OF FAN: HARDWIRE ISOLATION DAMPERS TO CLOSE UPON UNIT SHUTDOWN AND OPEN ON FAN START UP. ISOLATION DAMPERS SHALL BE HARDWIRE INTERLOCKED WITH THE FAN SYSTEM AND OPEN/CLOSE WITHOUT BAS INTERVENTION.
2. DAMPER END SWITCH FOR ISOLATION DAMPER PROOF: END SWITCH SHALL BE HARDWIRE INTERLOCKED TO PREVENT THE FAN FROM RUNNING UNTIL THE DAMPER HAS BEEN PROVED OPEN (TYPICALLY >90%) WITHOUT BAS INTERVENTION. END SWITCH SHALL ALSO PROVIDE STATUS TO THE BAS. UTILIZATION OF INTEGRAL ACTUATOR END SWITCH IS PROHIBITED.
3. HIGH STATIC PRESSURE LIMIT: PROVIDE A SEPARATE HIGH STATIC PRESSURE SWITCH (ADJ) TO STOP THE FAN WHEN STATIC PRESSURE RISES TO [###] IN W.G. WITH MANUAL RESET.
4. LOW STATIC PRESSURE LIMIT: PROVIDE A SEPARATE LOW STATIC PRESSURE SWITCH (ADJ) TO STOP THE FAN WHEN STATIC PRESSURE DROPS BELOW [###] IN W.G. WITH MANUAL RESET.

START-STOP SEQUENCES: PROVIDE THE FOLLOWING OPERATIONAL AND INTERLOCK FUNCTIONS WHEN THE AIR HANDLING UNIT FAN IS STARTED or STOPPED, UNLESS OTHERWISE NOTED. THESE SEQUENCES SHALL BE OPERATIONAL UPON PROOF OF FAN STATUS REGARDLESS OF MODE (HAND, OFF, AUTO, OR BYPASS)

1. ISOLATION DAMPER CONTROL: UPON INITIAL FAN START, OPEN ISOLATION DAMPERS TO 100%. UPON PROOF THAT ALL DAMPERS ARE OPEN (VIA END SWITCH) THE FAN SHALL BE ALLOWED TO RUN. IF FAN FAILS TO START WITHIN 60 SEC (ADJ) INITIATE A FAN FAILURE ALARM AT THE BAS.
2. STATIC PRESSURE CONTROL LOOP: ENABLE STATIC PRESSURE CONTROL LOOP UPON PROOF OF FAN START. DISABLE STATIC PRESSURE CONTROL LOOP UPON PROOF OF FAN STOP.

WHEN THE UNIT IS PROVEN ON IN RESPONSE TO THE BAS OR A MANUAL OVERRIDE, PROVIDE THE FOLLOWING.

FAN CONTROL LOOP: PROVIDE STATIC PRESSURE SENSORS MOUNTED AT THE UNIT AND ANOTHER REMOTE MOUNTED SENSOR LOCATED BY EOR. CONTROL THE VARIABLE SPEED DRIVE TO MAINTAIN THE CALCULATED REMOTE STATIC PRESSURE SET-POINT. IN THE EVENT THE REMOTE STATIC PRESSURE BECOMES UNRELIABLE, THE CONTROL SHALL REVERT TO THE LOCAL UNIT MOUNTED STATIC PRESSURE SENSOR LOCATED AT THE AHU AND INITIATE AN ALARM AT THE BAS. WHEN RUNNING FROM THE LOCAL UNIT MOUNTED STATIC PRESSURE SENSOR, THE STATIC PRESSURE SETPOINT SHALL BE RESET UP TO ENSURE ADEQUATE STATIC PRESSURE CONDITIONS WITHIN THE SYSTEM (ADJUSTED AND VERIFIED BY TAB). RETURN NORMAL STATIC PRESSURE CONTROL TO THE REMOTE STATIC SENSOR UPON SENSING A RELIABLE READING.

STATIC PRESSURE RESET CONTROL: THE BAS SHALL CONTINUOUSLY POLL THE DAMPER POSITION OF ALL AIR TERMINAL BOXES. THE BAS SHALL RESET STATIC PRESSURE SET-POINT UP OR DOWN TO CONTINUALLY RESET THE SYSTEM STATIC SETPOINT FOR OPTIMUM PERFORMANCE. SPECIFIC PARAMETERS AND TESTING PARAMETERS SHALL BE ESTABLISHED BY EOR. WHEN TWO OR MORE REMOTE STATIC PRESSURE SENSORS ARE USED, CONTROL TO THE SENSOR THAT IS FARTHEST FROM SETPOINT.

GENERAL NOTES

1. THIS DIAGRAM APPLIES TO ECONOMIZERS AS WELL AS AHU'S.

KEY NOTES

1. COORDINATE REQUIREMENT FOR OUTSIDE AIR FILTER WITH FACILITY SERVICES. WHEN USED SPECIFY METAL MESH WASHABLE TYPE.
2. EACH AHU SHALL INCLUDE AT LEAST ONE HUMIDITY SENSOR INSTALLED IN SPACE IN ADDITION TO UNIT MOUNTED SENSOR.
3. LOCATE REMOTE DISPLAY AT NO MORE THAN 6'-0" AFF WHENEVER POSSIBLE.

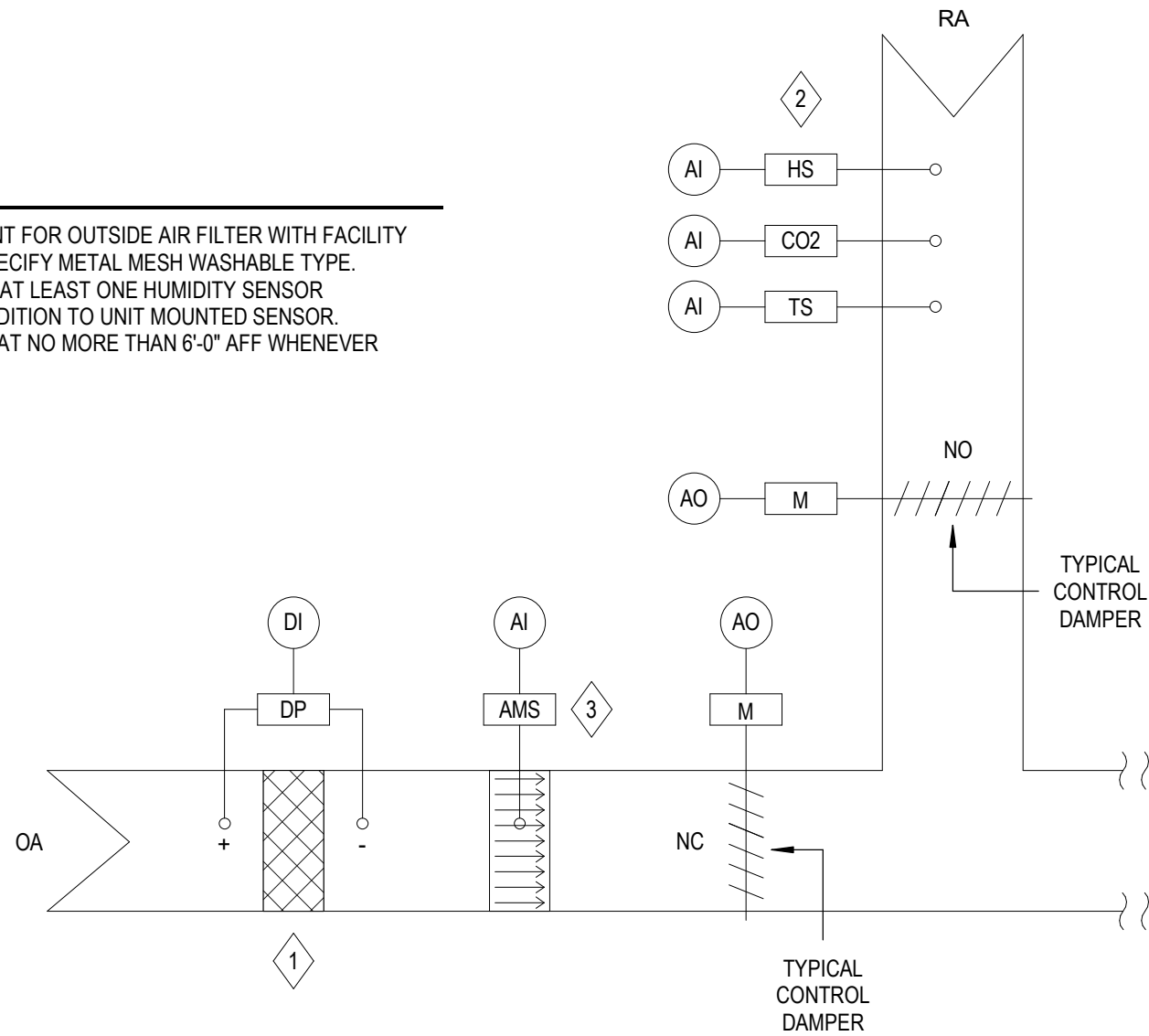

MIXED AIR AHU CONTROL SEQUENCE GUIDELINES (IC-1.06S)

NOTES TO THE ENGINEER:

1. THIS SEQUENCE GUIDE IS INTENDED TO PROVIDE THE DESIGN PROFESSIONAL WITH A BASIC GUIDELINE OF MINIMUM REQUIREMENTS FOR A TYPICAL MIXED AIR CONTROL. ALL PROPOSED MODIFICATIONS SHALL BE REVIEWED WITH UF FACILITY SERVICES (FS).
2. THE INTENT IS FOR THIS SEQUENCE TO BE INCLUDED IN THE CONTRACT DRAWINGS ALONG WITH THE CONTROL DIAGRAMS.
3. REFERENCE STANDARD CONTROL DIAGRAM IC-1.06D

PROVIDE THE FOLLOWING FOR AIR HANDLING UNIT.

1. NORMALLY CLOSED OUTSIDE AIR DAMPER CONTROL
2. NORMALLY OPEN RETURN AIR DAMPER CONTROL
3. OUTSIDE AIRFLOW STATION
4. OUTSIDE AIRFLOW FILTER

START-STOP SEQUENCES: PROVIDE THE FOLLOWING OPERATIONAL FUNCTIONS WHEN THE AIR HANDLING UNIT FAN IS STARTED OR STOPPED. THESE SEQUENCES SHALL BE OPERATIONAL UPON PROOF OF FAN STATUS REGARDLESS OF MODE (HAND, OFF, AUTO, OR BYPASS)

1. ENABLE OUTSIDE AIR CONTROL UPON PROOF OF FAN STATUS
2. FILTER DIFFERENTIAL PRESSURE SENSOR: PROVIDE DIFFERENTIAL PRESSURE SENSOR ACROSS THE FILTER SECTIONS. SIGNAL ALARM TO BAS OPERATOR WHEN THE SENSOR VALUE EXCEEDS xxx INWG.

WHEN THE UNIT IS PROVEN ON IN RESPONSE TO THE BAS OR A MANUAL OVERRIDE, PROVIDE THE FOLLOWING.

OUTDOOR AIR CONTROL: CALCULATE OUTSIDE AIRFLOW BY DIRECT MEASURE OF OUTSIDE AIRFLOW. MODULATE THE OUTSIDE AIR DAMPER AND RETURN AIR DAMPER IN SEQUENCE TO MAINTAIN THE CALCULATED OUTSIDE AIRFLOW SET-POINT REGARDLESS OF FAN SPEED OR FILTER LOADING. THE RETURN AND OUTSIDE AIR DAMPERS SHALL CONTROL AS FOLLOWS: STARTING WITH THE RETURN AIR DAMPER OPEN, MODULATE THE OUTSIDE AIR DAMPER OPEN/CLOSED AS REQUIRED TO MAINTAIN THE CALCULATED AIR FLOW SETPOINT. IN THE EVENT THE OUTSIDE AIR DAMPER IS FULLY OPEN (100%) AND THE OUTSIDE AIR VOLUME IS BELOW SET-POINT, BEGIN MODULATING THE RETURN AIR DAMPER TOWARDS ITS CLOSED POSITION BUT NOT LESS THAN 50% (ADJ).

DEMAND BASED VENTILATION: THE BAS SHALL POLL ALL CO2 SPACE SENSORS AND CALCULATE THE HIGHEST VALUE. THE OUTSIDE AIR CFM SETPOINT RANGE SHALL BE RESET IN ACCORDANCE WITH CO2 CHANGES. EOR TO ESTABLISH RESET PARAMETERS AND OBJECTIVES. DISABLE DEMAND VENTILATION SEQUENCE, RETURNING OA CFM SETPOINT TO SCHEDULED MAXIMUM, WHEN OUTDOOR TEMPERATURES DROP BELOW XXX DEG F TO ALLOW FOR FREE COOLING.

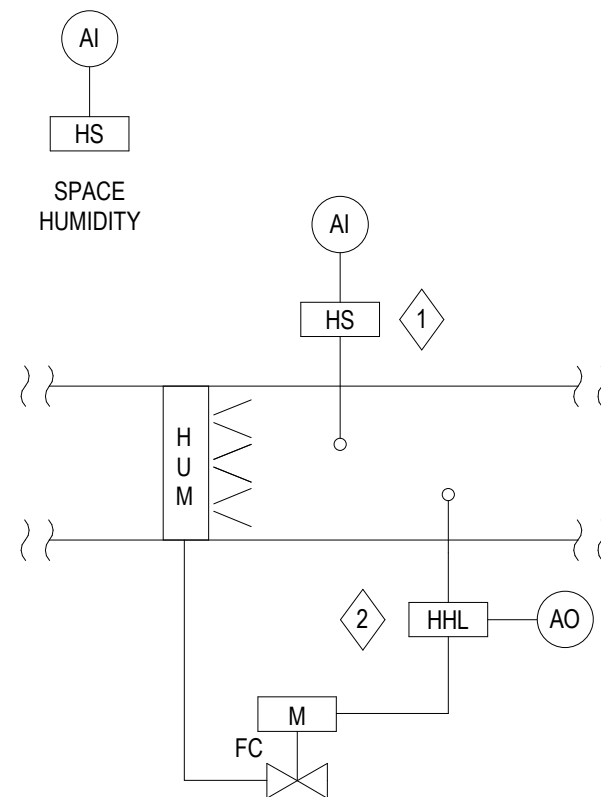

KEY NOTES

1. LOCATE A MINIMUM OF 20 FT DOWNSTREAM OF HUMIDIFIER TO BE USED IN CONJUNCTION WITH SUPPLY HUMIDITY RESET.
2. LOCATE HIGH LIMIT AT A MINIMUM OF 10 FT DOWNSTREAM. HIGH LIMIT SHALL DISABLE CONTROL FORCING THE HUMIDIFIER TO OFF WHEN HIGH LIMIT IS ACTIVE.

AHU HUMIDIFIER CONTROL SEQUENCE GUIDELINES (IC-1.07S)

NOTES TO THE ENGINEER:

1. THIS SEQUENCE GUIDE IS INTENDED TO PROVIDE THE DESIGN PROFESSIONAL WITH A BASIC GUIDELINE OF MINIMUM REQUIREMENTS FOR A TYPICAL HUMIDIFIER CONTROL. ALL PROPOSED MODIFICATIONS SHALL BE REVIEWED WITH UF FACILITY SERVICES (FS).
2. THE INTENT IS FOR THIS SEQUENCE TO BE INCLUDED IN THE CONTRACT DRAWINGS ALONG WITH THE CONTROL DIAGRAMS.
3. REFERENCE STANDARD CONTROL DIAGRAM IC-1.07D

PROVIDE THE FOLLOWING FOR AIR HANDLING UNIT.

1. HUMIDIFIER CONTROL WITH SPACE SENSORS AND HIGH LIMIT DEVICES

SAFETY CONTROL SEQUENCES: PROVIDE THE FOLLOWING SAFETY FUNCTIONS. ALL SAFETIES SHALL BE OPERATIONAL REGARDLESS OF FAN MODE (HAND, OFF, AUTO, OR BYPASS)

1. HIGH HUMIDITY LIMIT: PROVIDE HARD WIRED HIGH HUMIDITY LIMITING DEVICE TO DISABLE THE CONTROL SIGNAL UPON REACHING THE HIGH LIMIT THRESHOLD.

START-STOP SEQUENCES: PROVIDE THE FOLLOWING OPERATIONAL AND INTERLOCK FUNCTIONS WHEN THE AIR HANDLING UNIT FAN IS STARTED or STOPPED, UNLESS OTHERWISE NOTED. THESE SEQUENCES SHALL BE OPERATIONAL UPON PROOF OF FAN STATUS REGARDLESS OF MODE (HAND, OFF, AUTO, OR BYPASS)

2. HUMIDIFIER: ENABLE HUMIDIFIER CONTROL UPON PROOF OF FAN START. DISABLE HUMIDIFIER UPON PROOF OF FAN STOP.

WHEN THE UNIT IS PROVEN ON IN RESPONSE TO THE BAS OR A MANUAL OVERRIDE, PROVIDE THE FOLLOWING.

HUMIDIFIER CONTROL: BAS SHALL MODULATE THE HUMIDIFIER CONTROL VALVE AS NEEDED TO MAINTAIN A CALCULATED SUPPLY AIR HUMIDITY SETPOINT (AS SENSED DOWNSTREAM OF HUMIDIFIER). THE SPACE HUMIDITY SENSOR(S) SHALL BE ANALYZED TO DETERMINE THE HIGHEST AVERAGE HUMIDITY VALUE. THE SUPPLY AIR HUMIDITY SETPOINT SHALL BE RESET ACCORDING TO A SUPPLY AIR HUMIDITY RESET STRATEGY. ALL PARAMETERS TO BE DETERMINED BY EOR. SCHEDULE.

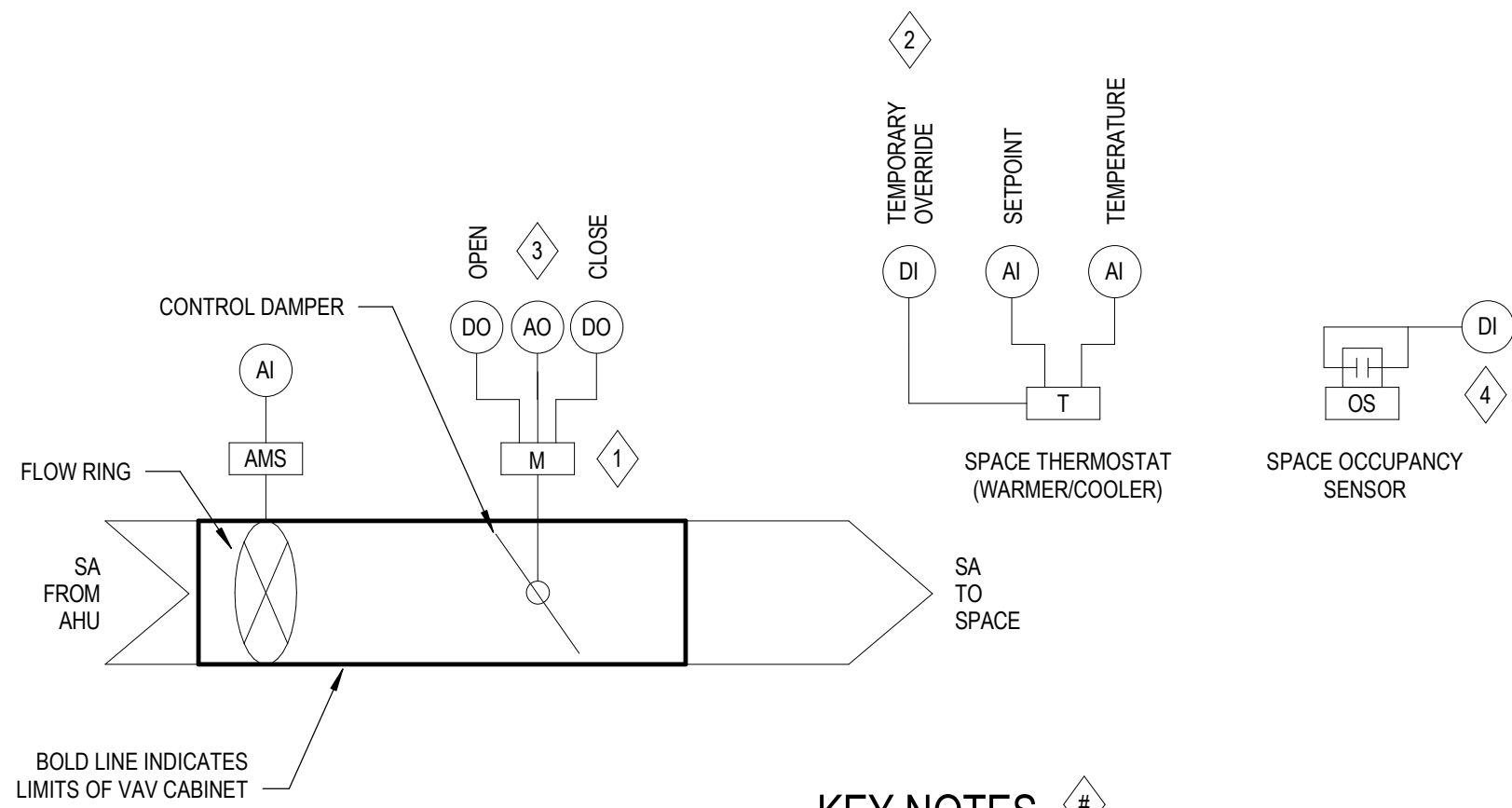

KEY NOTES

1. DAMPER SHALL BE EITHER PROPORTIONAL OR INCREMENTAL CONTROL SIGNAL.
2. INCLUDE TEMPORARY OVERRIDE CABABILITY BUT DISABLE. USE LOCAL OCCUPANCY SENSOR WHEN POSSIBLE.
3. EITHER ANALOG OR DIGITAL (FLOATING) CONTROL IS ACCEPTABLE.
4. WHEN UTILIZING MULTIPLE SENSORS, WIRE SENSORS IN PARALLEL TO ENSURE OCCUPANCY MODE IS TRIGGERED FROM ANY SPACE IN VAV ZONE.

VAV TERMINAL UNIT COOLING ONLY CONTROL SEQUENCE GUIDELINES (IC-1.08S)

NOTES TO THE ENGINEER:

1. THIS SEQUENCE GUIDE IS INTENDED TO PROVIDE THE DESIGN PROFESSIONAL WITH A BASIC GUIDELINE OF MINIMUM REQUIREMENTS FOR A TYPICAL COOLING ONLY VAV TERMINAL UNIT. ALL PROPOSED MODIFICATIONS SHALL BE REVIEWED WITH UF FACILITY SERVICES (FS).
2. THE INTENT IS FOR THIS SEQUENCE TO BE INCLUDED IN THE CONTRACT DRAWINGS ALONG WITH THE CONTROL DIAGRAMS.
3. REFERENCE STANDARD CONTROL DIAGRAM IC-1.08D

PROVIDE THE FOLLOWING FOR ALL AIR TERMINAL UNIT BOXES.

1. ROOM THERMOSTAT WITH INTEGRAL TEMPERATURE SENSOR, INTEGRAL DISPLAY, SLIDING SCALE SETPOINT ADJUSTMENT, AND REMOTE COMMUNICATION PORT.
2. PRESSURE INDEPENDENT AIR VOLUME CONTROL WITH ADJ MAXIMUM AND MINIMUM AIRFLOW SETTINGS.
3. OCCUPIED MODE SHALL BE DETERMINED BY BAS SCHEDULE OR LOCAL OCCUPANCY SENSOR. OCCUPANCY SENSOR SHALL TAKE PRECEDENT.

OCCUPIED MODE:

1. THE CONTROLLER SHALL CONTINUE TO MONITOR ROOM TEMPERATURE AND RESET THE CFM SETPOINT UP OR DOWN IN RESPONSE TO COOLING DEMAND.
2. OCCUPIED SETPOINT SHALL BE ACTIVE

UNOCCUPIED MODE 1 (ASSOCIATED AHU IS SCHEDULED OFF):

1. THE CONTROL AIR DAMPER SHALL REMAIN AT ITS MINIMUM POSITION (25% OPEN).
2. IN THE EVENT THE AHU IS ENABLED DURING UNOCCUPIED HOURS (I.E. DUE TO A HIGH ZONE CONDITIONS), THE BOX SHALL CONTROL ACCORDING TO THE OCCUPIED MODE DESCRIBED ABOVE BUT USING THE UNOCCUPIED SETPOINTS.
3. UPON ACTIVATION OF THE AHU BASED ON OCCUPANCY SENSOR ACTIVATION, THE ASSOCIATED AHU SHALL BE TEMPORARILY ACTIVATED AND THE TERMINAL UNIT SHALL RESUME NORMAL OCCUPIED MODE CONTROL. DEACTIVATION OF ALL LOCAL OCCUPANCY SENSORS SHALL RETURN THE TERMINAL UNIT TO THE UNOCCUPIED STATE AND CAUSE THE ASSOCIATED AHU TO SHUT DOWN.
4. TERMINAL UNIT AND ASSOCIATED AHU SHALL REMAIN OCCUPIED AND ACTIVE FOR A MINIMUM OF 1 HR (ADJ) ONCE ACTIVATED DURING UNOCCUPIED PERIODS.

UNOCCUPIED MODE 2 (ASSOCIATED AHU IS SCHEDULED ON DURING NORMAL OCCUPIED HOURS BUT OCCUPANCY SENSOR IS SHOWING NO OCCUPANCY):

1. THE VAV SHALL CONTINUE TO FUNCTION AS DESCRIBED UNDER OCCUPIED MODE WITH THE FOLLOWING ADJUSTMENTS.
2. THE MINIMUM CFM SETPOINT SHALL BE RESET DOWN TO XXX% OF THE DESIGN NORMAL MINIMUM.
3. COOLING OCCUPIED SETPOINTS SHALL BE ACTIVE.

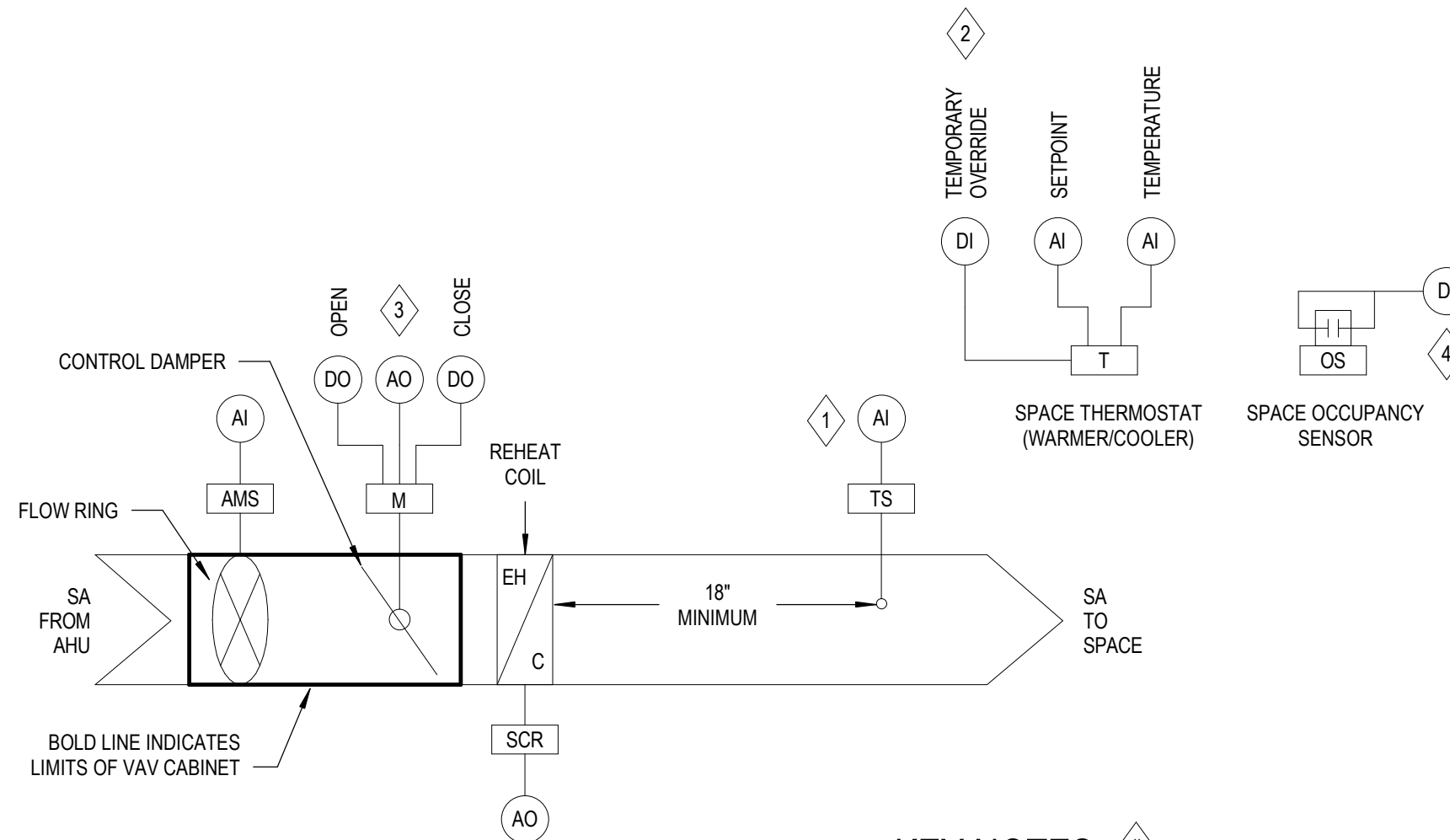

KEY NOTES

1. MAINTAIN A MINIMUM DISTANCE OF 18" DOWNSTREAM OF REHEAT COIL AND LOCATED IN CENTER OF DUCT.
2. INCLUDE TEMPORARY OVERRIDE CAPABILITY BUT DISABLE AND USE OCCUPANCY SENSOR AS THE PRIMARY TRIGGER FOR OCCUPIED MODE ACTIVATION.
3. EITHER ANALOG OR DIGITAL (FLOATING) CONTROL IS ACCEPTABLE.
4. WHEN UTILIZING MULTIPLE SENSORS, WIRE SENSORS IN PARALLEL TO ENSURE OCCUPANCY MODE IS TRIGGERED FROM ANY SPACE IN VAV ZONE.

VAV TERMINAL UNIT W/ ELECTRIC REHEAT CONTROL SEQUENCE GUIDELINES (IC-1.09S)

NOTES TO THE ENGINEER:

1. THIS SEQUENCE GUIDE IS INTENDED TO PROVIDE THE DESIGN PROFESSIONAL WITH A BASIC GUIDELINE OF MINIMUM REQUIREMENTS FOR A TYPICAL VAV TERMINAL UNIT WITH ELECTRIC HEAT. ALL PROPOSED MODIFICATIONS SHALL BE REVIEWED WITH UF FACILITY SERVICES (FS).
2. THE INTENT IS FOR THIS SEQUENCE TO BE INCLUDED IN THE CONTRACT DRAWINGS ALONG WITH THE CONTROL DIAGRAMS.
3. REFERENCE STANDARD CONTROL DIAGRAM IC-1.09D

PROVIDE THE FOLLOWING FOR ALL AIR TERMINAL UNIT BOXES.

1. ROOM THERMOSTAT WITH INTEGRAL TEMPERATURE SENSOR, INTEGRAL DISPLAY, SLIDING SCALE SETPOINT ADJUSTMENT, AND REMOTE COMMUNICATION PORT.
2. PRESSURE INDEPENDENT AIR VOLUME CONTROL WITH ADJ MAXIMUM AND MINIMUM AIRFLOW SETTINGS.
3. OCCUPIED MODE SHALL BE DETERMINED BY BAS SCHEDULE OR LOCAL OCCUPANCY SENSOR. OCCUPANCY SENSOR SHALL TAKE PRECEDENT.

OCCUPIED MODE:

1. THE CONTROLLER SHALL CONTINUE TO MONITOR ROOM TEMPERATURE AND RESET THE CFM SETPOINT UP OR DOWN IN RESPONSE TO COOLING DEMAND.
2. OCCUPIED SETPOINTS SHALL BE ACTIVE
3. ON A CONTINUED FALL IN ROOM TEMPERATURE, CONTINUE DELIVERING THE SCHEDULED MINIMUM AIR FLOW WHILE INCREASING THE ELECTRIC HEAT OUTPUT TO MAINTAIN THE HEATING SETPOINT.
4. OCCUPIED SETPOINTS SHALL BE ACTIVE. EOR TO ESTABLISH REQUIRED HEATING AND COOLING SETPOINTS

UNOCCUPIED MODE 1 (ASSOCIATED AHU IS SCHEDULED OFF):

1. THE CONTROL AIR DAMPER SHALL REMAIN AT ITS MINIMUM POSITION (25% OPEN).
2. IN THE EVENT THE AHU IS ENABLED DURING UNOCCUPIED HOURS (I.E. DUE TO A HIGH ZONE CONDITIONS), THE BOX SHALL CONTROL ACCORDING TO THE OCCUPIED MODE DESCRIBED ABOVE BUT USING THE UNOCCUPIED SETPOINTS.
3. UPON ACTIVATION OF THE AHU BASED ON OCCUPANCY SENSOR ACTIVATION, THE ASSOCIATED AHU SHALL BE TEMPORARILY ACTIVATED AND THE TERMINAL UNIT SHALL RESUME NORMAL OCCUPIED MODE CONTROL. DEACTIVATION OF ALL LOCAL OCCUPANCY SENSORS SHALL RETURN THE TERMINAL UNIT TO THE UNOCCUPIED STATE AND CAUSE THE ASSOCIATED AHU TO SHUT DOWN.
4. TERMINAL UNIT AND ASSOCIATED AHU SHALL REMAIN OCCUPIED AND ACTIVE FOR A MINIMUM OF 1 HR (ADJ) ONCE ACTIVATED DURING UNOCCUPIED PERIODS.

UNOCCUPIED MODE 2 (ASSOCIATED AHU IS SCHEDULED ON DURING NORMAL OCCUPIED HOURS BUT OCCUPANCY SENSOR IS SHOWING NO OCCUPANCY):

1. THE VAV SHALL CONTINUE TO FUNCTION AS DESCRIBED UNDER OCCUPIED MODE WITH THE FOLLOWING ADJUSTMENTS.
2. THE MINIMUM CFM SETPOINT SHALL BE RESET DOWN TO XXX% OF THE DESIGN NORMAL MINIMUM.
3. COOLING/HEATING OCCUPIED SETPOINTS SHALL BE ACTIVE.

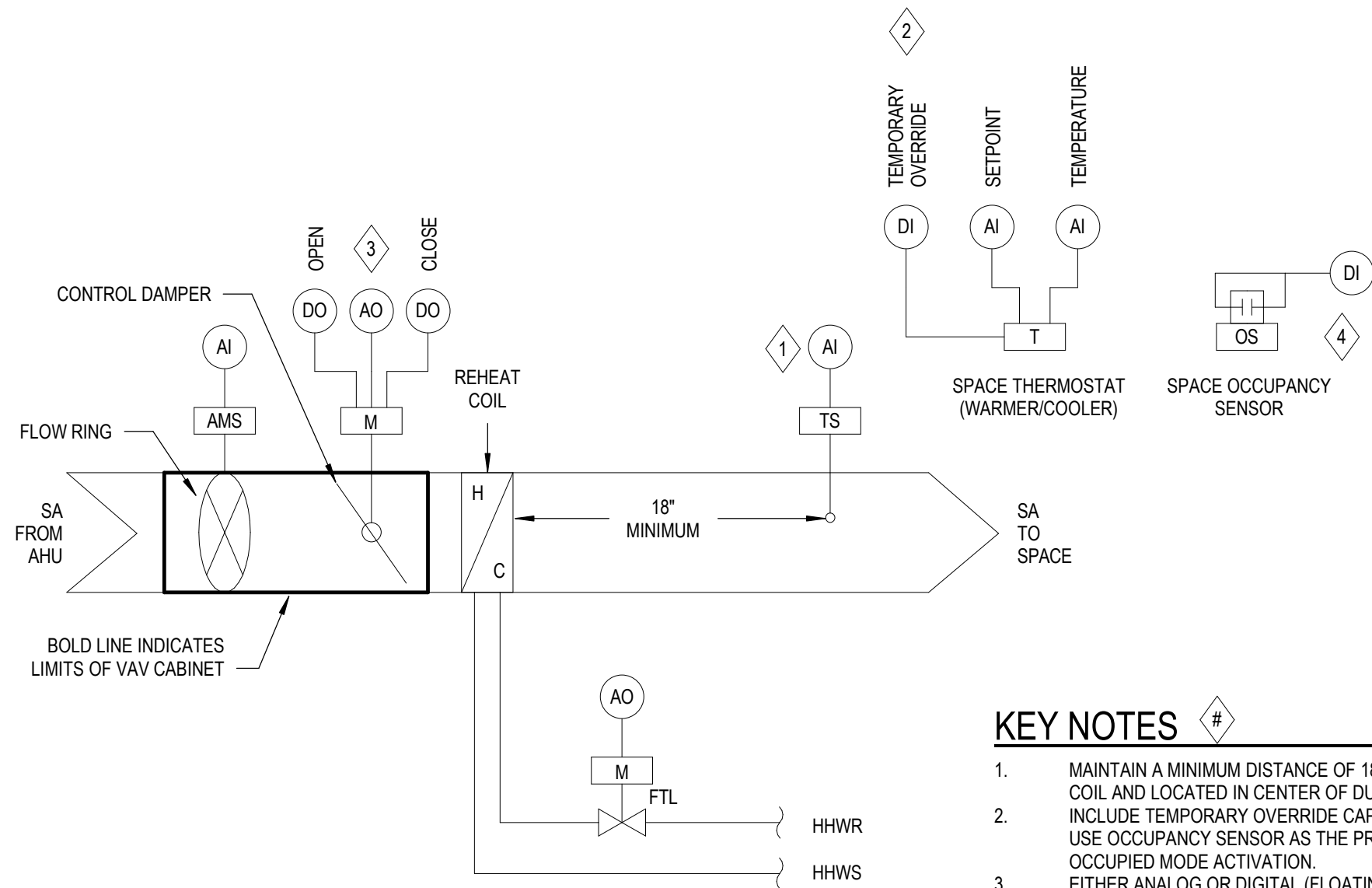

KEY NOTES #

1. MAINTAIN A MINIMUM DISTANCE OF 18" DOWNSTREAM OF REHEAT COIL AND LOCATED IN CENTER OF DUCT.
2. INCLUDE TEMPORARY OVERRIDE CAPABILITY BUT DISABLE AND USE OCCUPANCY SENSOR AS THE PRIMARY TRIGGER FOR OCCUPIED MODE ACTIVATION.
3. EITHER ANALOG OR DIGITAL (FLOATING) CONTROL IS ACCEPTABLE.
4. WHEN UTILIZING MULTIPLE SENSORS, WIRE SENSORS IN PARALLEL TO ENSURE OCCUPANCY MODE IS TRIGGERED FROM ANY SPACE IN VAV ZONE.

VAV TERMINAL UNIT W/ HHW REHEAT CONTROL SEQUENCE GUIDELINES (IC-1.10S)

NOTES TO THE ENGINEER:

1. THIS SEQUENCE GUIDE IS INTENDED TO PROVIDE THE DESIGN PROFESSIONAL WITH A BASIC GUIDELINE OF MINIMUM REQUIREMENTS FOR A TYPICAL VAV TERMINAL UNIT WITH HOT WATER REHEAT. ALL PROPOSED MODIFICATIONS SHALL BE REVIEWED WITH UF FACILITY SERVICES (FS).
2. THE INTENT IS FOR THIS SEQUENCE TO BE INCLUDED IN THE CONTRACT DRAWINGS ALONG WITH THE CONTROL DIAGRAMS.
3. REFERENCE STANDARD CONTROL DIAGRAM IC-1.10D

PROVIDE THE FOLLOWING FOR ALL AIR TERMINAL UNIT BOXES.

1. ROOM THERMOSTAT WITH INTEGRAL TEMPERATURE SENSOR, INTEGRAL DISPLAY, SLIDING SCALE SETPOINT ADJUSTMENT, AND REMOTE COMMUNICATION PORT.
2. PRESSURE INDEPENDENT AIR VOLUME CONTROL WITH ADJ MAXIMUM AND MINIMUM AIRFLOW SETTINGS.
3. OCCUPIED MODE SHALL BE DETERMINED BY BAS SCHEDULE OR LOCAL OCCUPANCY SENSOR. OCCUPANCY SENSOR SHALL TAKE PRECEDENT.

OCCUPIED MODE:

1. THE CONTROLLER SHALL CONTINUE TO MONITOR ROOM TEMPERATURE AND RESET THE CFM SETPOINT UP OR DOWN IN RESPONSE TO COOLING DEMAND.
2. OCCUPIED SETPOINTS SHALL BE ACTIVE
3. ON A CONTINUED FALL IN ROOM TEMPERATURE, CONTINUE DELIVERING THE SCHEDULED MINIMUM AIR FLOW WHILE INCREASING THE HOT WATER HEAT OUTPUT TO MAINTAIN THE HEATING SETPOINT.
4. OCCUPIED SETPOINTS SHALL BE ACTIVE. EOR TO ESTABLISH REQUIRED HEATING AND COOLING SETPOINTS

UNOCCUPIED MODE 1 (ASSOCIATED AHU IS SCHEDULED OFF):

1. THE CONTROL AIR DAMPER SHALL REMAIN AT ITS MINIMUM POSITION (25% OPEN).
2. IN THE EVENT THE AHU IS ENABLED DURING UNOCCUPIED HOURS (I.E. DUE TO A HIGH ZONE CONDITIONS), THE BOX SHALL CONTROL ACCORDING TO THE OCCUPIED MODE DESCRIBED ABOVE BUT USING THE UNOCCUPIED SETPOINTS.
3. UPON ACTIVATION OF THE AHU BASED ON OCCUPANCY SENSOR ACTIVATION, THE ASSOCIATED AHU SHALL BE TEMPORARILY ACTIVATED AND THE TERMINAL UNIT SHALL RESUME NORMAL OCCUPIED MODE CONTROL. DEACTIVATION OF ALL LOCAL OCCUPANCY SENSORS SHALL RETURN THE TERMINAL UNIT TO THE UNOCCUPIED STATE AND CAUSE THE ASSOCIATED AHU TO SHUT DOWN.
4. TERMINAL UNIT AND ASSOCIATED AHU SHALL REMAIN OCCUPIED AND ACTIVE FOR A MINIMUM OF 1 HR (ADJ) ONCE ACTIVATED DURING UNOCCUPIED PERIODS.

UNOCCUPIED MODE 2 (ASSOCIATED AHU IS SCHEDULED ON DURING NORMAL OCCUPIED HOURS BUT OCCUPANCY SENSOR IS SHOWING NO OCCUPANCY):

1. THE VAV SHALL CONTINUE TO FUNCTION AS DESCRIBED UNDER OCCUPIED MODE WITH THE FOLLOWING ADJUSTMENTS.
2. THE MINIMUM CFM SETPOINT SHALL BE RESET DOWN TO XXX% OF THE DESIGN NORMAL MINIMUM.
3. COOLING/HEATING OCCUPIED SETPOINTS SHALL BE ACTIVE.

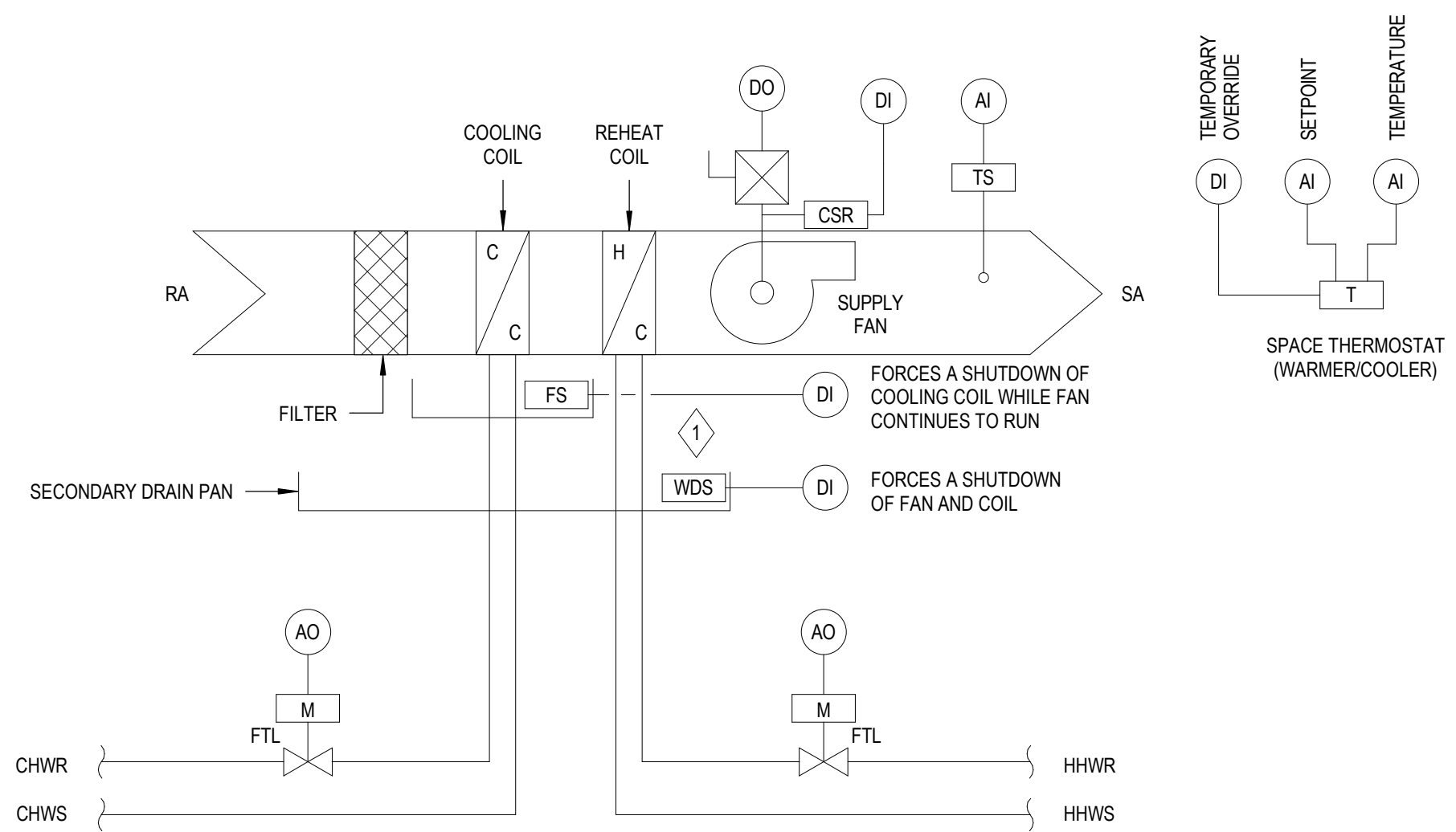

KEY NOTES

1. WATER DETECTION SENSOR TO TRIGGER UPON SENSING ANY WATER IN SECONDARY DRAIN PAN. SIMILAR TO DWYER WDS-LP-D2-A.

FCU HTG/CLG CONTROL SEQUENCE GUIDELINES (IC-1.11S)

NOTES TO THE ENGINEER:

- 1. THIS SEQUENCE GUIDE IS INTENDED TO PROVIDE THE DESIGN PROFESSIONAL WITH A BASIC GUIDELINE OF MINIMUM REQUIREMENTS FOR A TYPICAL FAN COIL CONTROL. ALL PROPOSED MODIFICATIONS SHALL BE REVIEWED WITH UF FACILITY SERVICES (FS).
- 2. THE INTENT IS FOR THIS SEQUENCE TO BE INCLUDED IN THE CONTRACT DRAWINGS ALONG WITH THE CONTROL DIAGRAMS.
- 3. REFERENCE STANDARD CONTROL DIAGRAM IC-1.11D

PROVIDE THE FOLLOWING FOR FAN COIL UNIT:

- 1. ROOM THERMOSTAT WITH INTEGRAL TEMPERATURE SENSOR, INTEGRAL DISPLAY, SLIDING SCALE SETPOINT ADJUSTMENT, AND REMOTE COMMUNICATION PORT.
- 2. DISCHARGE AIR TEMPERATURE SENSOR AND FILTER PRESSURE SWITCH.
- 3. HEATING AND COOLING CONTROL.
- 4. FAN CONTROL.
- 5. FLOAT SWITCH IN PRIMARY PAN AND WATER DETECTION UNIT IN SECONDARY DRAIN PAN WHEN APPLICABLE.

SAFETY CONTROL SEQUENCES:

- 1. CONDENSATE OVERFLOW: UPON THE DETECTION OF WATER IN THE PRIMARY DRAIN PAN, FULLY CLOSE THE COOLING CONTROL VALVE, FAN REMAINS ACTIVE AND ALARM AT THE BAS. UPON THE DETECTION OF WATER IN THE SECONDARY DRAIN PAN, FULLY CLOSE THE COOLING CONTROL VALVE, SHUT DOWN FAN AND ALARM AT THE BAS.

TEMPERATURE CONTROL:

- 1. START THE FCU FAN AND PROVE FAN ON PRIOR TO ACTIVATION OF TEMPERATURE CONTROL.
- 2. MODULATE HEATING AND COOLING COILS AS NEEDED TO MAINTAIN SPACE CONDITIONS. EOR TO ESTABLISH APPROPRIATE SETPOINTS AND APPROPRIATE DEADBAND FOR AREAS SERVED.

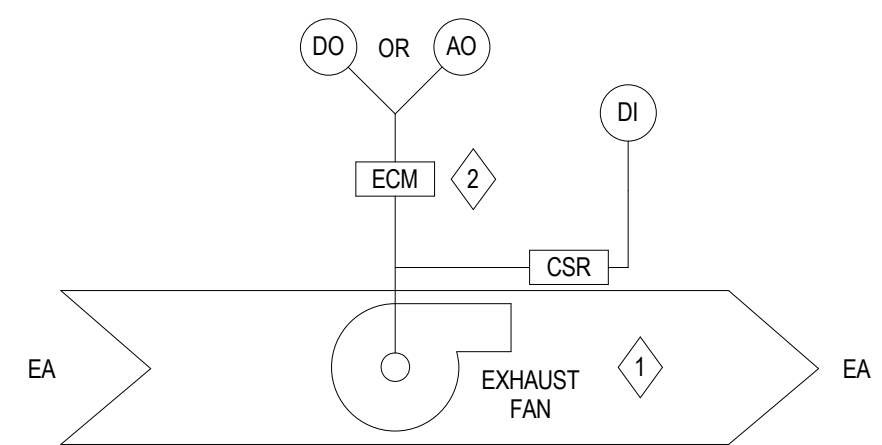
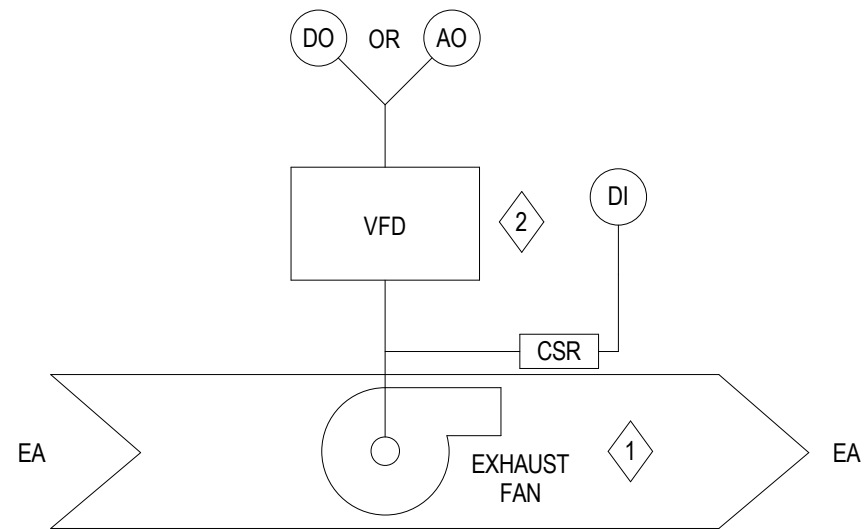

KEY NOTES #

1. INTERLOCK EXHAUST FANS WITH AHUS TO ENSURE PRESSURIZATION IS MAINTAINED AT ALL TIMES.
2. UTILIZE VFD OR ECM VARIABLE SPEED MOTOR WHENEVER POSSIBLE FOR MAXIMUM FLEXIBILITY AND ADJUSTABILITY.

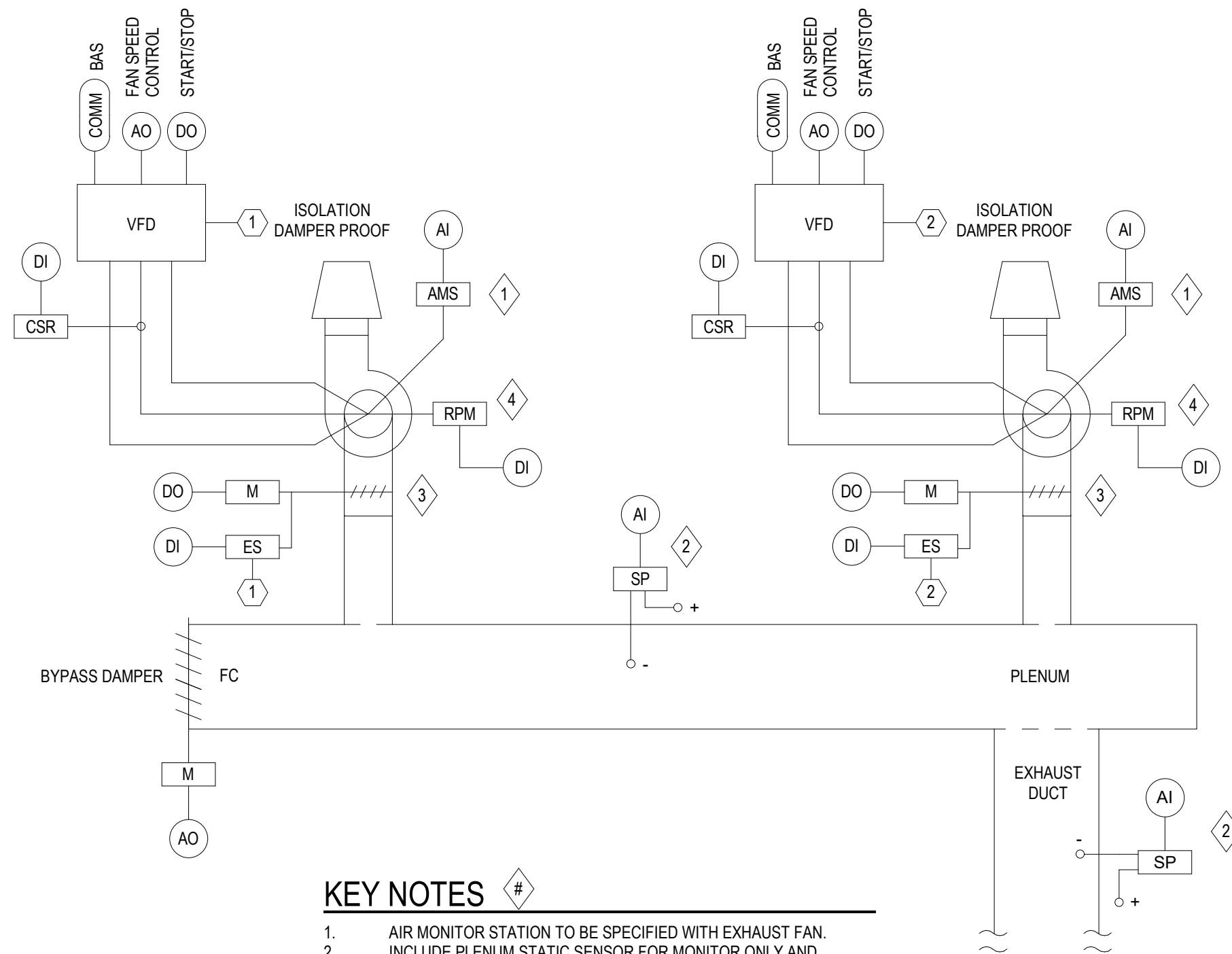

KEY NOTES #

1. AIR MONITOR STATION TO BE SPECIFIED WITH EXHAUST FAN.
2. INCLUDE PLENUM STATIC SENSOR FOR MONITOR ONLY AND BACKUP CONTROL. USE REMOTE DUCT MOUNTED SENSOR(S) FOR STATIC PRESSURE CONTROL.
3. USE MOTORIZED ISOLATION DAMPERS WHEN POSSIBLE.
4. UTILIZE RPM SENSOR FOR NO-RUN STATUS WHEN POSSIBLE. SIMILAR TO ELECTRO-SENSOR M100T.

EXHAUST MULTI-FAN MANIFOLD CONTROL SEQUENCE GUIDELINES (IC-1.13S)

NOTES TO THE ENGINEER:

1. THIS SEQUENCE GUIDE IS INTENDED TO PROVIDE THE DESIGN PROFESSIONAL WITH A BASIC GUIDELINE OF MINIMUM REQUIREMENTS FOR A TYPICAL MANIFOLDED EXHAUST SYSTEM CONTROL. ALL PROPOSED MODIFICATIONS SHALL BE REVIEWED WITH UF FACILITY SERVICES (FS).
2. THE INTENT IS FOR THIS SEQUENCE TO BE INCLUDED IN THE CONTRACT DRAWINGS ALONG WITH THE CONTROL DIAGRAMS.
3. REFERENCE STANDARD CONTROL DIAGRAM IC-1.13D

PROVIDE THE FOLLOWING FOR EXHAUST SYSTEM.

1. VARIABLE FREQUENCY DRIVE AND BYPASS DAMPERS WITH STATIC PRESSURE CONTROL.
2. AUTOMATIC FAN ROTATION AND FAN FAILURE STANDBY CONTROL.
3. NORMAL FAN OPERATION SHALL REQUIRE AT LEAST TWO FANS RUNNING IN PARALLEL WITH FULL EXHAUST SYSTEM SIZED FOR N+1 REDUNDANCY.

START-STOP SEQUENCES: PROVIDE THE FOLLOWING OPERATIONAL AND INTERLOCK FUNCTIONS WHEN THE EXHAUST SYSTEM IS STARTED AND STOPPED. UNLESS OTHERWISE NOTED THESE SEQUENCES SHALL BE FUNCTIONAL FOR ANY REASON THE FAN STARTS OR STOPS IN ANY MODE OF OPERATION (ALL H-O-A MODES, ALL VFD MODES, ALL AUTOMATIC AND SAFETY FUNCTIONS, AND LOCAL MANUAL START-STOP).

1. **BYPASS DAMPERS:** OPEN BYPASS DAMPERS TO THE MINIMUM 25% POSITION UPON INITIAL STARTUP. CLOSE BYPASS DAMPERS UPON EXHAUST SYSTEM STOP.
2. **FANS:** RAMP FAN UP TO MINIMUM SPEED UPON INITIAL STARTUP. OPEN ISOLATION DAMPER UPON PROOF OF STATUS VIA RPM FEEDBACK SENSOR.

FAN SPEED CONTROL: MAINTAIN REMOTE STATIC PRESSURE SENSOR SETPOINT USING A COMBINATION OF FAN SPEED CONTROL AND BYPASS DAMPER MODULATION. USE PLENUM STATIC PRESSURE AS THE BACKUP CONTROL SENSOR WHEN REMOTE SENSOR IS UNRELIABLE. IN GENERAL, CONTROL THE VARIABLE SPEED DRIVE FROM MINIMUM TO MAXIMUM SPEED TO MAINTAIN THE STATIC PRESSURE SETPOINT AND ONLY MODULATE BYPASS DAMPER AFTER FAN SPEED HAS REACHED ITS MINIMUM DESIGN SPEED.

SINGLE EXHAUST FAN FAILURE: IN THE EVENT THE RUNNING EXHAUST FAN FAILS, IMMEDIATELY START THE STANDBY EXHAUST FAN. THE STANDBY FAN WILL REMAIN ON AND BE RE-DESIGNATED AS A NEW PRIMARY FAN. THE FAILED FAN SHALL MAINTAIN ITS ALARM CONDITION UNTIL A BAS RESET IS INITIATED TO BRING THE FAILED FAN OUT OF ITS ALARM CONDITION. NOTE: REGARDLESS OF STANDBY FAN ALARM STATE THE BAS SHALL MAKE AN ATTEMPT TO START THE STANDBY FAN IN THE EVENT OF ANOTHER PRIMARY FAN FAILURE.

1. **EXHAUST SYSTEM ROTATION SEQUENCE:** UPON SIGNAL FROM THE BAS TO ROTATE THE EXHAUST FANS (BY SCHEDULE OR MANUAL INITIATION). DEFINE FAN CONDITION, SETPOINTS AND TIMERS AS NEEDED TO MINIMIZE SYSTEM STATIC PRESSURE VARIATION.

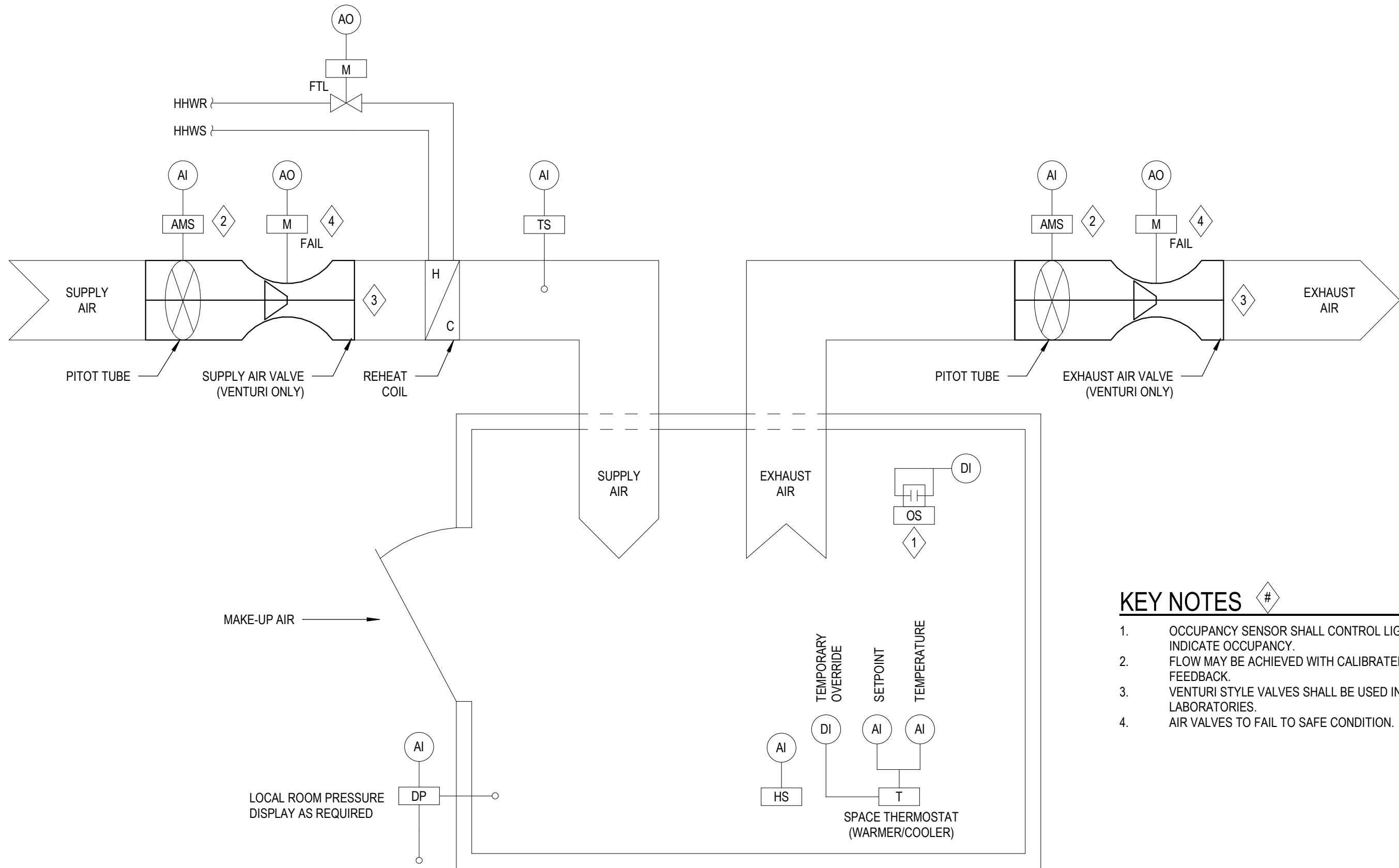

KEY NOTES #

1. OCCUPANCY SENSOR SHALL CONTROL LIGHTS AND SIGNAL BAS TO INDICATE OCCUPANCY.
2. FLOW MAY BE ACHIEVED WITH CALIBRATED MECHANICAL FEEDBACK.
3. VENTURI STYLE VALVES SHALL BE USED IN ALL BSL2 AND BSL3 LABORATORIES.
4. AIR VALVES TO FAIL TO SAFE CONDITION.

LAB – SUPPLY/EXHAUST/TRACKING CONTROL SEQUENCE GUIDELINE (IC-1.14S)

NOTES TO THE ENGINEER:

1. THIS SEQUENCE GUIDE IS INTENDED TO PROVIDE THE DESIGN PROFESSIONAL WITH A BASIC GUIDELINE OF MINIMUM REQUIREMENTS FOR A TYPICAL LABORATORY SUPPLY/EXHAUST TRACKING SYSTEM. ALL PROPOSED MODIFICATIONS SHALL BE REVIEWED WITH UF FACILITY SERVICES (FS).
2. THE INTENT IS FOR THIS SEQUENCE TO BE INCLUDED IN THE CONTRACT DRAWINGS ALONG WITH THE CONTROL DIAGRAMS.
3. REFERENCE STANDARD CONTROL DIAGRAM IC-1.14D

PROVIDE THE FOLLOWING FOR ALL LABORATORIES:

1. ROOM THERMOSTAT WITH INTEGRAL TEMPERATURE SENSOR, INTEGRAL DISPLAY, SLIDING SCALE SETPOINT ADJUSTMENT, AND REMOTE COMMUNICATION PORT.
2. SPACE HUMIDITY SENSOR
3. A SUPPLY TERMINAL UNIT WITH REHEAT COIL AND GENERAL EXHAUST TERMINAL UNIT.
4. SUPPLY AIR TEMPERATURE SENSOR DOWNSTREAM OF THE SUPPLY TERMINAL REHEAT COIL FOR USE IN MONITORING OVERALL TERMINAL UNIT PERFORMANCE.
5. INCLUDE SUPPLY AIRFLOW SENSOR AND EXHAUST AIRFLOW SENSOR FOR THE LAB CONTROLLER TO MONITOR AND MAINTAIN A SCHEDULED AIRFLOW OFFSET.
6. OCCUPIED MODE AS DETERMINED BY SCHEDULE OR LOCAL OCCUPANCY SENSOR.

OCCUPIED MODE:

1. THE LAB CONTROLLER SHALL MAINTAIN OCCUPIED TEMPERATURE SETPOINTS AND MINIMUM VENTILATION RATES. REFER TO SCHEDULE FOR MINIMUM OCCUPIED CFM SETPOINTS TO ESTABLISH MINIMUM VENTILATION RATES DURING OCCUPIED MODE.

UNOCCUPIED MODE:

1. THE LAB CONTROLLER SHALL MAINTAIN UNOCCUPIED MINIMUM VENTILATION RATES DURING UNOCCUPIED MODE. REFER TO SCHEDULE FOR MINIMUM UNOCCUPIED CFM SETPOINTS TO ESTABLISH MINIMUM VENTILATION RATES DURING UNOCCUPIED MODE.

ROOM VENTILATION CONTROL:

1. THE LAB CONTROLLER SHALL CALCULATE TOTAL ROOM SUPPLY CFM AS NEEDED TO SATISFY ROOM TEMPERATURE SETPOINT OR MINIMUM VENTILATION RATES.
2. THE LAB CONTROLLER SHALL THEN MODULATE THE ROOM EXHAUST AIR TERMINAL(S) FROM ITS SCHEDULED MINIMUM TO MAXIMUM FLOW SETPOINT TO MAINTAIN A FIXED OFFSET OF [###] CFM (ADJ) WITHIN THE LAB TO MANAGE DESIGN PRESSURIZATION (POSITIVE, NEGATIVE, OR NEUTRAL).
3. MINIMUM VENTILATION RATES SHALL BE ADJUSTED IN RESPONSE TO OCCUPANCY STATUS. SEE SCHEDULE FOR MINIMUM/MAXIMUM SETTINGS UNDER OCCUPIED AND UNOCCUPIED MODES.

ROOM TEMPERATURE CONTROL:

1. SUPPLY AIR TERMINAL SHALL BE MODULATED BETWEEN ITS ESTABLISHED MINIMUM AND MAXIMUM FLOWS TO MAINTAIN THE COOLING SETPOINT. CONTROL SHALL BE CONTINUOUS REGARDLESS OF OCCUPANCY STATUS. THE HEATING VALVE SHALL BE MODULATED TO MAINTAIN THE HEATING SETPOINT. THE HEATING VALVE SHALL NOT OPEN UNTIL SUPPLY TERMINAL HAS REACHED ITS MINIMUM FLOW SETPOINT OR UNTIL THE SUPPLY VALVE CAN NO LONGER TURN DOWN DUE TO MINIMUM VENTILATION.

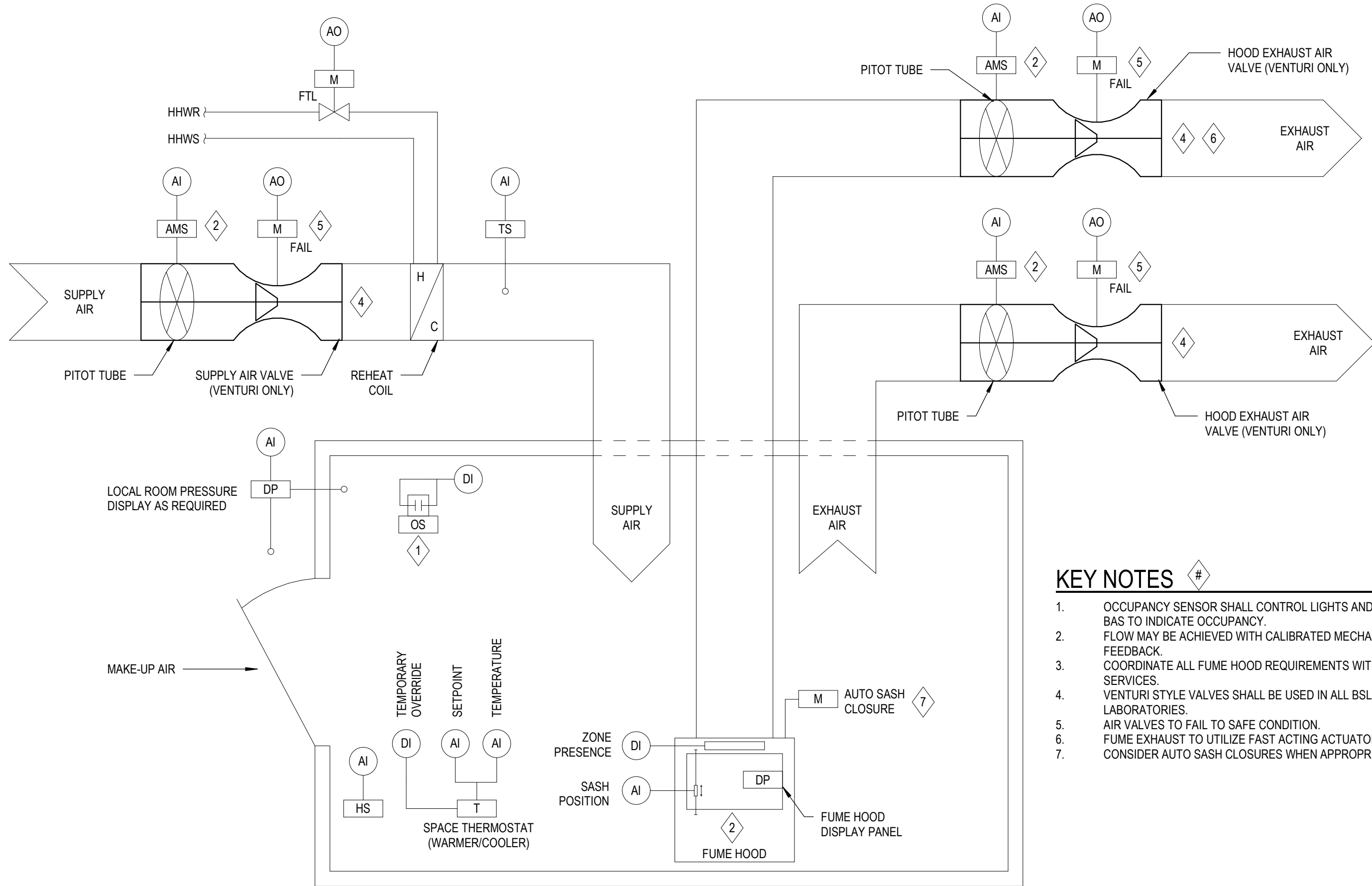

KEY NOTES

1. OCCUPANCY SENSOR SHALL CONTROL LIGHTS AND SIGNAL BAS TO INDICATE OCCUPANCY.
2. FLOW MAY BE ACHIEVED WITH CALIBRATED MECHANICAL FEEDBACK.
3. COORDINATE ALL FUME HOOD REQUIREMENTS WITH FACILITY SERVICES.
4. VENTURI STYLE VALVES SHALL BE USED IN ALL BSL2 AND BSL3 LABORATORIES.
5. AIR VALVES TO FAIL TO SAFE CONDITION.
6. FUME EXHAUST TO UTILIZE FAST ACTING ACTUATORS.
7. CONSIDER AUTO SASH CLOSURES WHEN APPROPRIATE.

LAB – SUPPLY/EXHAUST/FUME/TRACKING CONTROL SEQUENCE GUIDELINE (IC-1.15S)

NOTES TO THE ENGINEER:

1. THIS SEQUENCE GUIDE IS INTENDED TO PROVIDE THE DESIGN PROFESSIONAL WITH A BASIC GUIDELINE OF MINIMUM REQUIREMENTS FOR A TYPICAL LABORATORY SUPPLY/EXHAUST/HOOD TRACKING SYSTEM. ALL PROPOSED MODIFICATIONS SHALL BE REVIEWED WITH UF FACILITY SERVICES (FS).
2. THE INTENT IS FOR THIS SEQUENCE TO BE INCLUDED IN THE CONTRACT DRAWINGS ALONG WITH THE CONTROL DIAGRAMS.
3. REFERENCE STANDARD CONTROL DIAGRAM IC-1.15D

PROVIDE THE FOLLOWING FOR ALL LABORATORIES:

1. ROOM THERMOSTAT WITH INTEGRAL TEMPERATURE SENSOR, INTEGRAL DISPLAY, SLIDING SCALE SETPOINT ADJUSTMENT, AND REMOTE COMMUNICATION PORT.
2. SPACE HUMIDITY SENSOR
3. A SUPPLY TERMINAL UNIT WITH REHEAT COIL, GENERAL EXHAUST TERMINAL UNIT, AND HOOD EXHAUST TERMINAL UNIT.
4. SUPPLY AIR TEMPERATURE SENSOR DOWNSTREAM OF THE SUPPLY TERMINAL REHEAT COIL FOR USE IN MONITORING OVERALL TERMINAL UNIT PERFORMANCE.
5. INCLUDE SUPPLY AIRFLOW SENSOR AND EXHAUST AIRFLOW SENSOR FOR THE LAB CONTROLLER TO MONITOR AND MAINTAIN A SCHEDULED AIRFLOW OFFSET.
6. INCLUDE HOOD AIR FLOW SENSOR TO ENSURE CORRECT AIRFLOW WITHIN HOOD
7. OCCUPIED MODE AS DETERMINED BY SCHEDULE OR LOCAL OCCUPANCY SENSOR.

OCCUPIED MODE:

1. THE LAB CONTROLLER SHALL MAINTAIN OCCUPIED TEMPERATURE SETPOINTS AND MINIMUM VENTILATION RATES. REFER TO SCHEDULE FOR MINIMUM OCCUPIED CFM SETPOINTS TO ESTABLISH MINIMUM VENTILATION RATES DURING OCCUPIED MODE.

UNOCCUPIED MODE:

1. THE LAB CONTROLLER SHALL MAINTAIN UNOCCUPIED MINIMUM VENTILATION RATES DURING UNOCCUPIED MODE. REFER TO SCHEDULE FOR MINIMUM UNOCCUPIED CFM SETPOINTS TO ESTABLISH MINIMUM VENTILATION RATES DURING UNOCCUPIED MODE.

ROOM VENTILATION CONTROL:

1. THE LAB CONTROLLER SHALL CALCULATE TOTAL ROOM SUPPLY CFM AS NEEDED TO SATISFY ROOM TEMPERATURE SETPOINT OR MINIMUM VENTILATION RATES.
2. THE LAB CONTROLLER SHALL THEN MODULATE THE ROOM EXHAUST AIR TERMINAL(S) FROM ITS SCHEDULED MINIMUM TO MAXIMUM FLOW SETPOINT TO MAINTAIN A FIXED OFFSET OF [###] CFM (ADJ) WITHIN THE LAB TO MANAGE DESIGN PRESSURIZATION (POSITIVE, NEGATIVE, OR NEUTRAL). HOOD FLOW SHALL BE FACTORED INTO THE OVERALL OFFSET CALCULATION.
3. MINIMUM VENTILATION RATES SHALL BE ADJUSTED IN RESPONSE TO OCCUPANCY STATUS. SEE SCHEDULE FOR MINIMUM/MAXIMUM SETTINGS UNDER OCCUPIED AND UNOCCUPIED MODES.

ROOM TEMPERATURE CONTROL:

1. SUPPLY AIR TERMINAL SHALL BE MODULATED BETWEEN ITS ESTABLISHED MINIMUM AND MAXIMUM FLOWS TO MAINTAIN THE COOLING SETPOINT. CONTROL SHALL BE CONTINUOUS REGARDLESS OF OCCUPANCY STATUS.
2. THE HEATING VALVE SHALL BE MODULATED TO MAINTAIN THE HEATING SETPOINT. THE HEATING VALVE SHALL NOT OPEN UNTIL SUPPLY TERMINAL HAS REACHED ITS MINIMUM FLOW SETPOINT OR UNTIL THE SUPPLY VALVE CAN NO LONGER TURN DOWN DUE TO MINIMUM VENTILATION.

HOOD CONTROL:

1. THE HOOD CONTROLLER SHALL MAINTAIN CONTINUOUS FLOW AT THE FACE OF THE HOOD IN ACCORDANCE WITH HOOD REQUIREMENTS.
2. UTILIZE VARIABLE FLOW HOODS WHENEVER POSSIBLE.

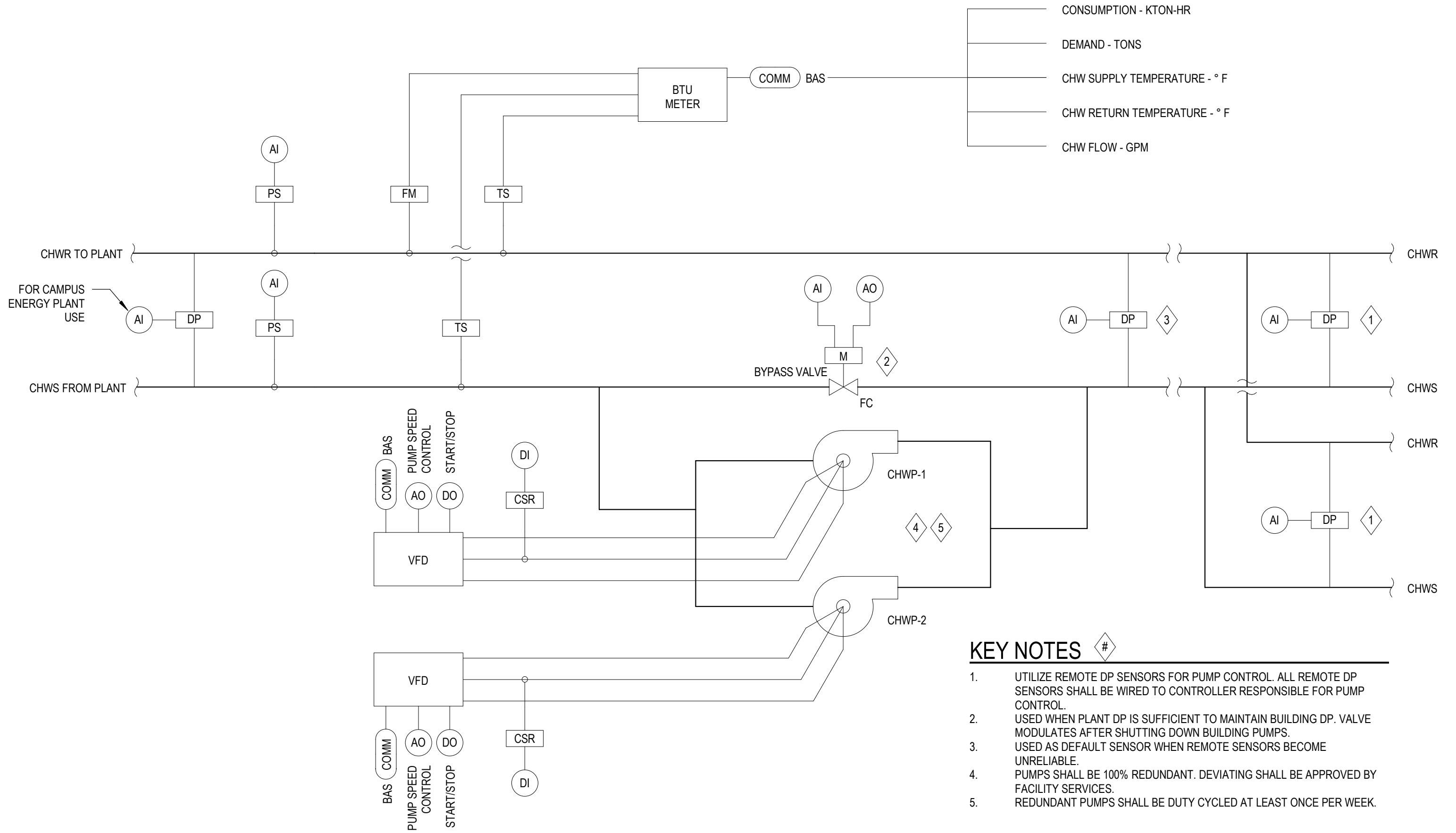

KEY NOTES

1. UTILIZE REMOTE DP SENSORS FOR PUMP CONTROL. ALL REMOTE DP SENSORS SHALL BE WIRED TO CONTROLLER RESPONSIBLE FOR PUMP CONTROL.
2. USED WHEN PLANT DP IS SUFFICIENT TO MAINTAIN BUILDING DP. VALVE MODULATES AFTER SHUTTING DOWN BUILDING PUMPS.
3. USED AS DEFAULT SENSOR WHEN REMOTE SENSORS BECOME UNRELIABLE.
4. PUMPS SHALL BE 100% REDUNDANT. DEVIATING SHALL BE APPROVED BY FACILITY SERVICES.
5. REDUNDANT PUMPS SHALL BE DUTY CYCLED AT LEAST ONCE PER WEEK.

CHILLED WATER BUILDING DUAL PUMPING CONTROL SEQUENCE GUIDELINE (IC-1.16S)

NOTES TO THE ENGINEER:

1. THIS SEQUENCE GUIDE IS INTENDED TO PROVIDE THE DESIGN PROFESSIONAL WITH A BASIC GUIDELINE OF MINIMUM REQUIREMENTS FOR A TYPICAL BUILDING CHILLED WATER PUMPING PACKAGE. ALL PROPOSED MODIFICATIONS SHALL BE REVIEWED WITH UF FACILITY SERVICES (FS).
2. THE INTENT IS FOR THIS SEQUENCE TO BE INCLUDED IN THE CONTRACT DRAWINGS ALONG WITH THE CONTROL DIAGRAMS.
3. REFERENCE STANDARD CONTROL DIAGRAM IC-1.16D

PROVIDE THE FOLLOWING FOR CHILLED WATER PUMPING SYSTEMS:

1. APPROPRIATE TEMPERATURE, FLOW AND PRESSURE SENSORS.
2. CHILLED WATER BTU METER.
3. DIFFERENTIAL PRESSURE SENSORS FOR PUMP CONTROL.
4. SYSTEM ENABLE/DISABLE SHALL BE DETERMINED BY BUILDING OCCUPANCY SCHEDULE AND AHU STATUS.

START-STOP SEQUENCE: UPON STARTUP ENABLE PUMP CONTROL. UPON SHUTDOWN, DISABLE ALL PUMP CONTROL. THIS SEQUENCE SHALL BE FUNCTIONAL FOR ANY REASON THE PUMP STARTS-STOPS IN ANY MODE OF OPERATION (ALL H-O-A MODES, ALL VFD MODES, ALL AUTOMATIC AND SAFETY FUNCTIONS, AND LOCAL MANUAL START-STOP).

PUMP CONTROL (LEAD/STANDBY EACH PUMP SIZED AT 100%):

1. ONCE ENABLED THE PUMP SPEED SHALL BE MODULATED TO MAINTAIN THE CALCULATED DIFFERENTIAL PRESSURE SETPOINT.
2. SOFTWARE LEAD/STANDBY PUMP CONTROL FUNCTION SHALL ALLOW EITHER OF THE CHILLED WATER PUMPS TO ACT AS THE LEAD PUMP, WHILE DESIGNATING THE OTHER PUMP AS A STANDBY PUMP.
3. DIFFERENTIAL PRESSURE RESET CONTROL: THE BAS SHALL CONTINUOUSLY POLL THE VALVE POSITION OF ALL AIR CHILLED WATER COILS. THE BAS SHALL RESET DIFFERENTIAL PRESSURE SET-POINT UP OR DOWN TO CONTINUALLY RESET THE SYSTEM DIFFERENTIAL PRESSURE SETPOINT FOR OPTIMUM PERFORMANCE. SPECIFIC PARAMETERS AND TESTING PARAMETERS SHALL BE ESTABLISHED BY EOR. WHEN TWO REMOTE DIFFERENTIAL PRESSURE SENSORS ARE USED, CONTROL TO THE SENSOR THAT IS FARTHEST FROM SETPOINT.
4. IN THE EVENT REMOTE DIFFERENTIAL PRESSURE SENSORS BECOME UNRELIABLE, UTILIZE LOCAL DIFFERENTIAL PRESSURE FOR PUMP CONTROL TAKING INTO CONSIDERATION THE ADJUSTED SETPOINT
5. ALARM ON PUMP FAILURE DETECTED VIA CURRENT SENSING SWITCH. UPON FAILURE OF THE LEAD PUMP, THE STANDBY PUMP SHALL START AUTOMATICALLY. THE BAS SHALL MAINTAIN A START COMMAND AT THE LEAD PUMP AND RESUME CONTROL WHEN THE LEAD PUMP HAS RETURNED TO NORMAL OPERATION.
6. LEAD PUMP DESIGNATION SHALL BE ROTATED WEEKLY (ADJ) IN ACCORDANCE WITH THE BAS SCHEDULE.

PUMP ROTATION: UPON SIGNAL FROM THE BAS TO ROTATE THE PUMPS, EXECUTE THE FOLLOWING SEQUENCE.

1. INITIATE ROTATION IN ACCORDANCE WITH A BAS SCHEDULE OR BY MANUAL INITIATION.
2. WHILE THE CURRENT LEAD PUMP IS STILL ACTIVE START THE STANDBY PUMP AND DESIGNATE AS THE NEW LEAD PUMP.
3. UPON PROOF OF NEW STANDBY PUMP RUNNING STATUS VIA CURRENT SENSING RELAY, COMMAND THE NEWLY DESIGNATED STANDBY PUMP TO OFF.
4. MAINTAIN DIFFERENTIAL PRESSURE CONTROL WITH THE NEW LEAD PUMP.

MINIMUM UPSTREAM STRAIGHT RUN REQUIRED	
OBSTRUCTION	UPSTREAM
SINGLE BEND PRECEDED BY ≥ 9 DIAMETERS OF STRAIGHT PIPE RUN	10 DIA
PIPE SIZE REDUCTION / EXPANSION IN STRAIGHT RUN	10 DIA
SINGLE BEND PRECEDED BY ≤ 9 DIAMETERS OF STRAIGHT PIPE RUN	15 DIA
OUTFLOWING TEE / PUMP OUTFLOW	20 DIA
MULTIPLE BENDS OUT OF PLANE	30 DIA
INFLOWING TEE	30 DIA
CONTROL / MODULATING VALVE	30 DIA

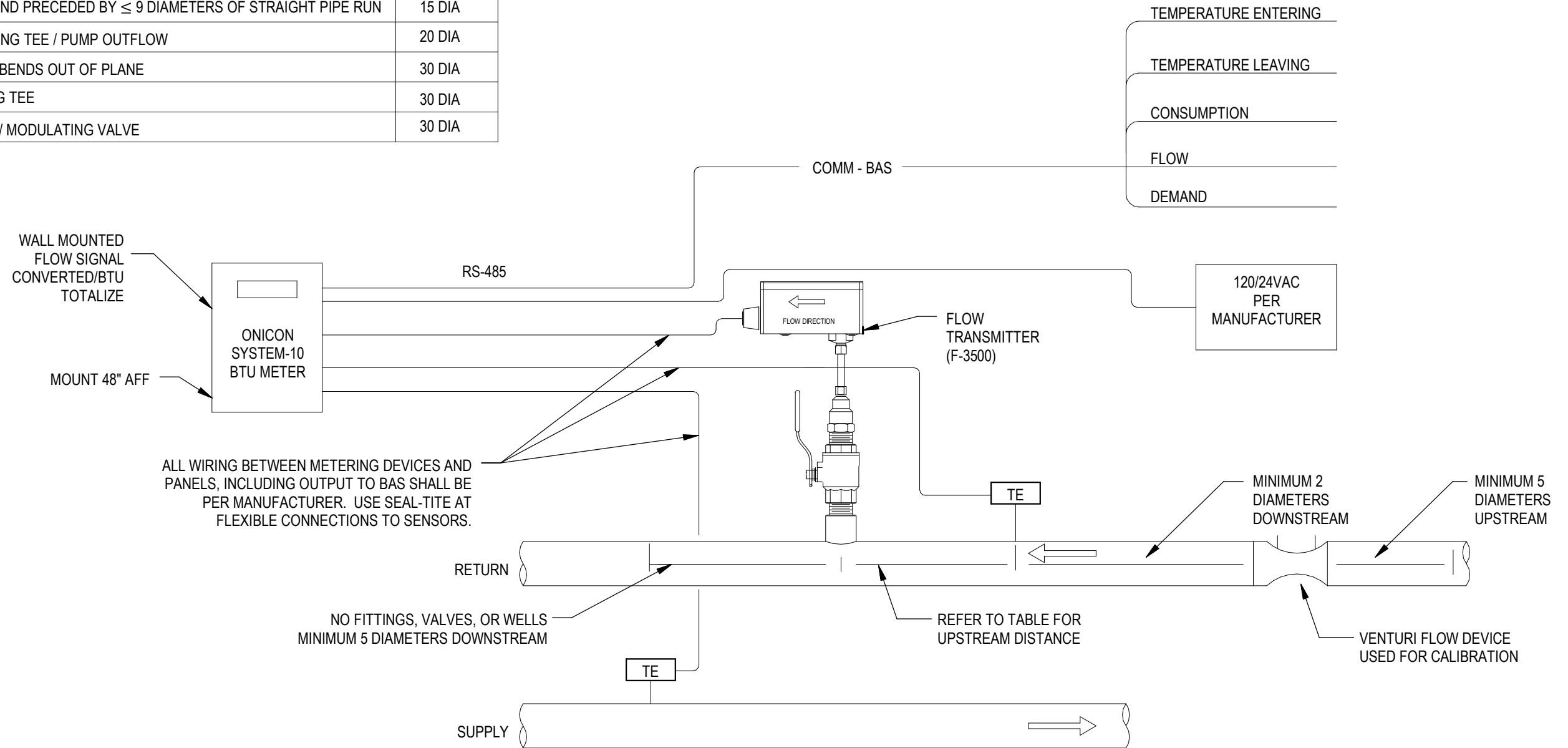

SHOWN TRANSDUCER: CDM2N52; MOUNTED IN TWO (2) SOUND PATHS
 SHOWN PERMALOK: MOU-PLM-RS-SSKX

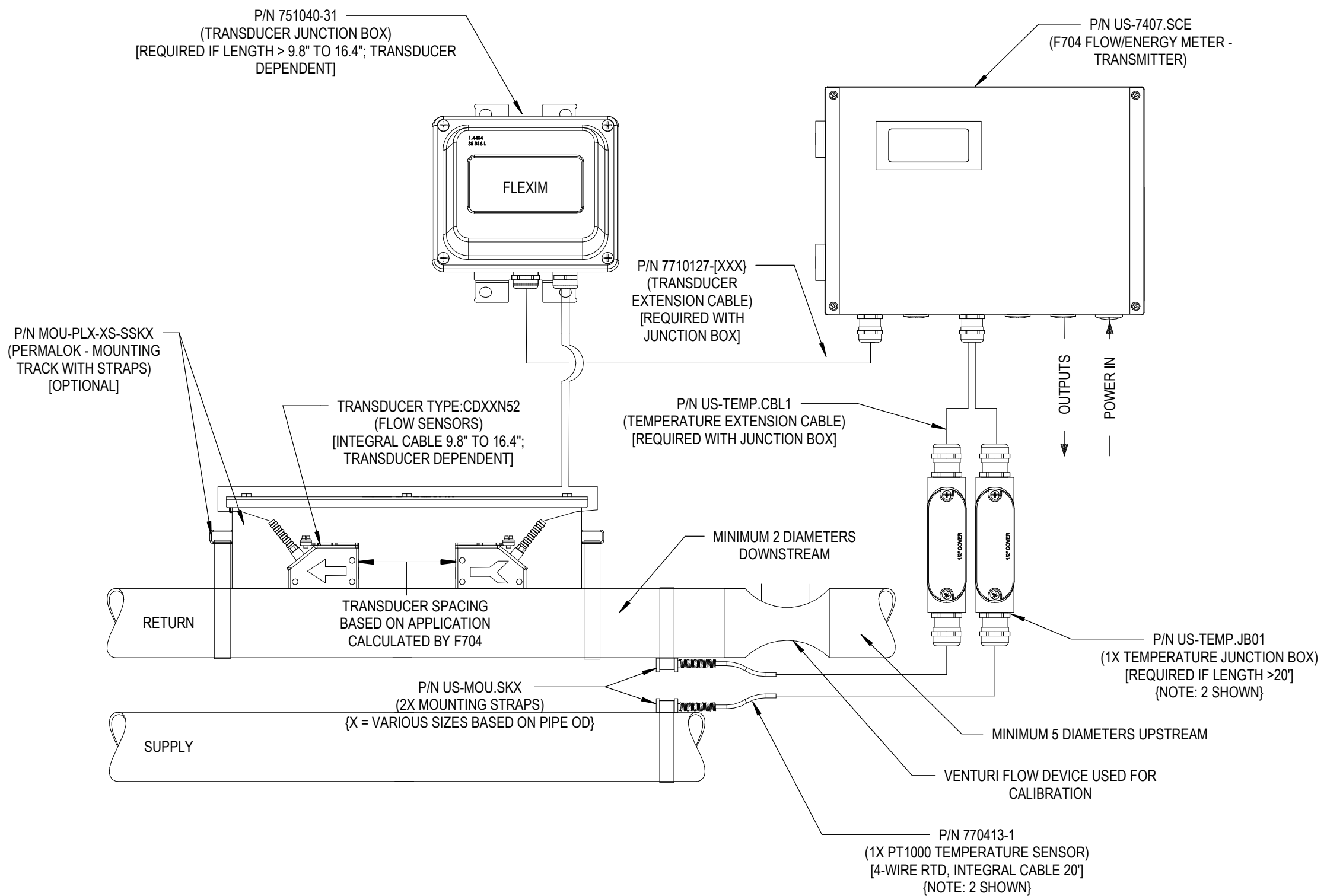

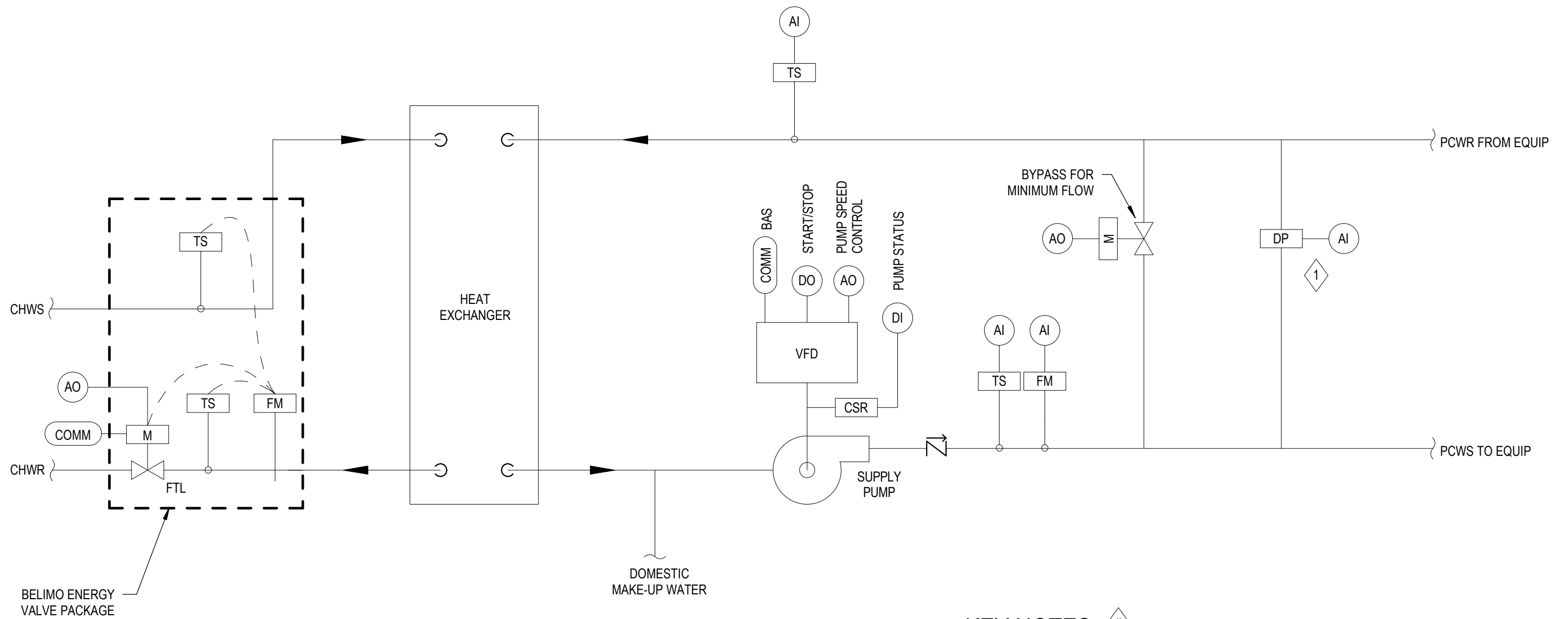

KEY NOTES #

1. UTILIZE REMOTE DP SENSORS FOR PUMP CONTROL. ALL REMOTE DP SENSORS SHALL BE WIRED TO CONTROLLER RESPONSIBLE FOR PUMP CONTROL.

PROCESS CHILLED WATER SYSTEM CONTROL SEQUENCE GUIDELINE (IC-1.19S)

NOTES TO THE ENGINEER:

1. THIS SEQUENCE GUIDE IS INTENDED TO PROVIDE THE DESIGN PROFESSIONAL WITH A BASIC GUIDELINE OF MINIMUM REQUIREMENTS FOR A TYPICAL PROCESS WATER CONTROL SYSTEM. ALL PROPOSED MODIFICATIONS SHALL BE REVIEWED WITH UF FACILITY SERVICES (FS).
2. THE INTENT IS FOR THIS SEQUENCE TO BE INCLUDED IN THE CONTRACT DRAWINGS ALONG WITH THE CONTROL DIAGRAMS.
3. REFERENCE STANDARD CONTROL DIAGRAM IC-1.19D

PROVIDE THE FOLLOWING FOR PROCESS WATER PUMPING SYSTEMS:

1. APPROPRIATE TEMPERATURE, FLOW AND PRESSURE SENSORS.
2. BYPASS VALVE FOR PRESSURE RELIEF.
3. SYSTEM ENABLE/DISABLE SHALL BE DETERMINED BY BAS OR LOCAL SWITCH.

START-STOP SEQUENCE: UPON START-UP, ENABLE THE PRIMARY PUMP CONTROL AND TEMPERATURE CONTROL. UPON SHUTDOWN, DISABLE ALL PUMPS, CLOSE CHILLED WATER VALVE AND OPEN BYPASS VALVE. THIS SEQUENCE SHALL BE FUNCTIONAL FOR ANY REASON THE PUMP STARTS-STOPS IN ANY MODE OF OPERATION (ALL H-O-A MODES, ALL VFD MODES, ALL AUTOMATIC AND SAFETY FUNCTIONS, AND LOCAL MANUAL START-STOP).

ENABLE MODE:

1. THE BAS SHALL ENABLE THE PROCESS WATER PUMPING SYSTEM AND HEAT EXCHANGER UPON PROOF OF PUMP FLOW.
2. BYPASS VALVE SHALL START IN THE FULL BYPASS POSITION.
3. VERIFY PUMPS ARE RUNNING BY WAY OF PUMP STATUS AND WATER FLOW METER.
4. UPON VERIFICATION THAT PUMP(S) ARE ON AND WATER IS FLOWING, ENABLE THE PUMP CONTROL SEQUENCE.

PUMP CONTROL

1. ONCE ENABLED THE PUMP SPEED SHALL BE MODULATED TO MAINTAIN THE DIFFERENTIAL PRESSURE SETPOINT.
2. UPON AN INCREASE IN DIFFERENTIAL PRESSURE AND AFTER THE PUMP HAS REACHED ITS MINIMUM SPEED, MODULATE THE BYPASS VALVE TO MAINTAIN DP SETPOINT.
3. ALARM ON PUMP FAILURE DETECTED VIA CURRENT SENSING SWITCH.
4. WHEN UTILIZING TWO PUMPS, SIZE PUMPS FOR 100% AND FOLLOW LEAD/STANDBY SEQUENCE DESCRIBED UNDER CHILLED WATER PUMP SEQUENCE IC-1.16S

HX CONTROL

1. ONCE FLOW HAS BEEN VERIFIED ON THE PROCESS SIDE, ENABLE THE HEAT EXCHANGER CHILLED WATER VALVE CONTROL.
2. MODULATE THE HX CONTROL VALVE TO MAINTAIN THE PROCESS LEAVING TEMPERATURE SETPOINT.

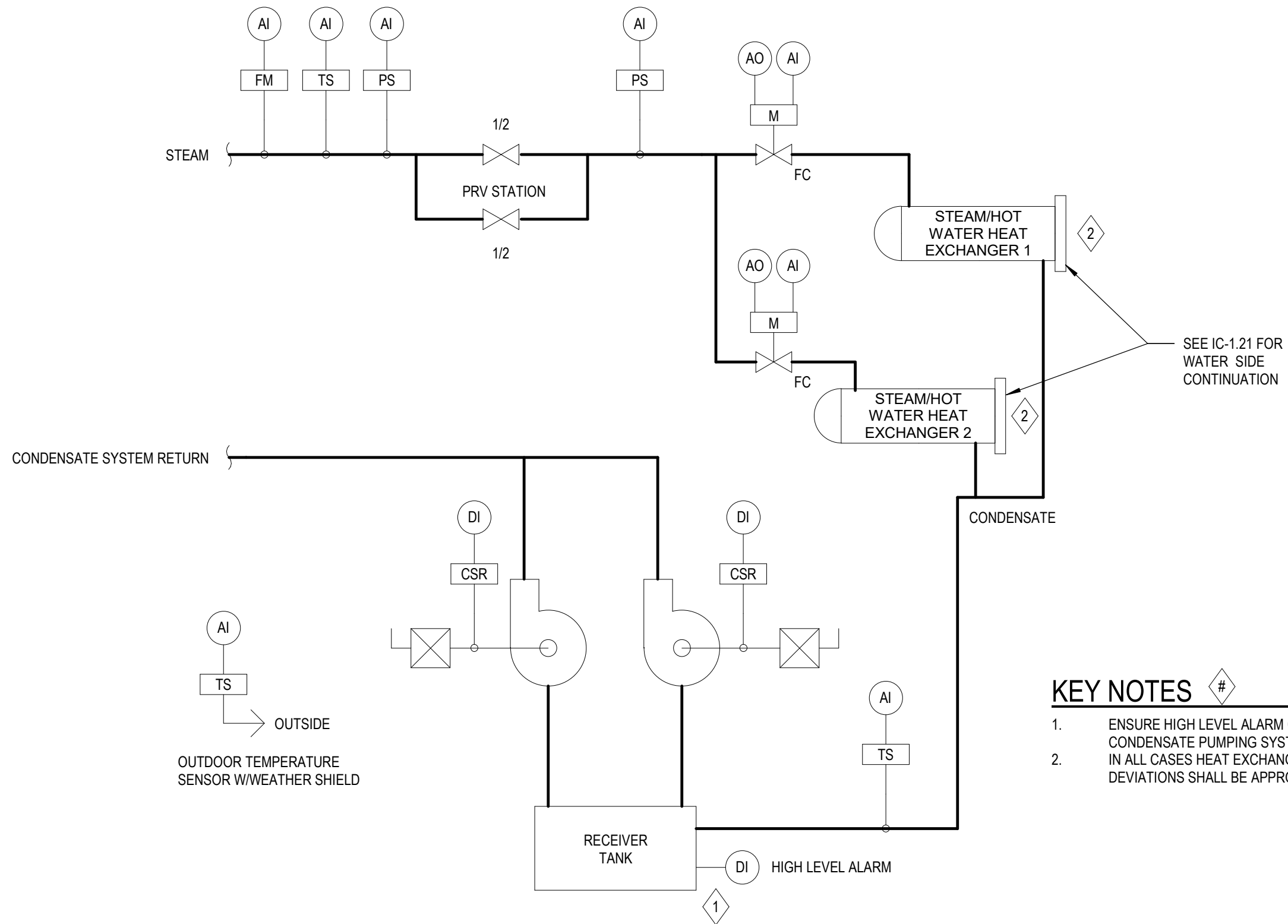

SEE IC-1.21 FOR WATER SIDE CONTINUATION

KEY NOTES #

1. ENSURE HIGH LEVEL ALARM CONTACT IS SPECIFIED WITH CONDENSATE PUMPING SYSTEM.
2. IN ALL CASES HEAT EXCHANGERS SHALL BE 100% REDUNDANT. DEVIATIONS SHALL BE APPROVED BY FACILITY SERVICES.

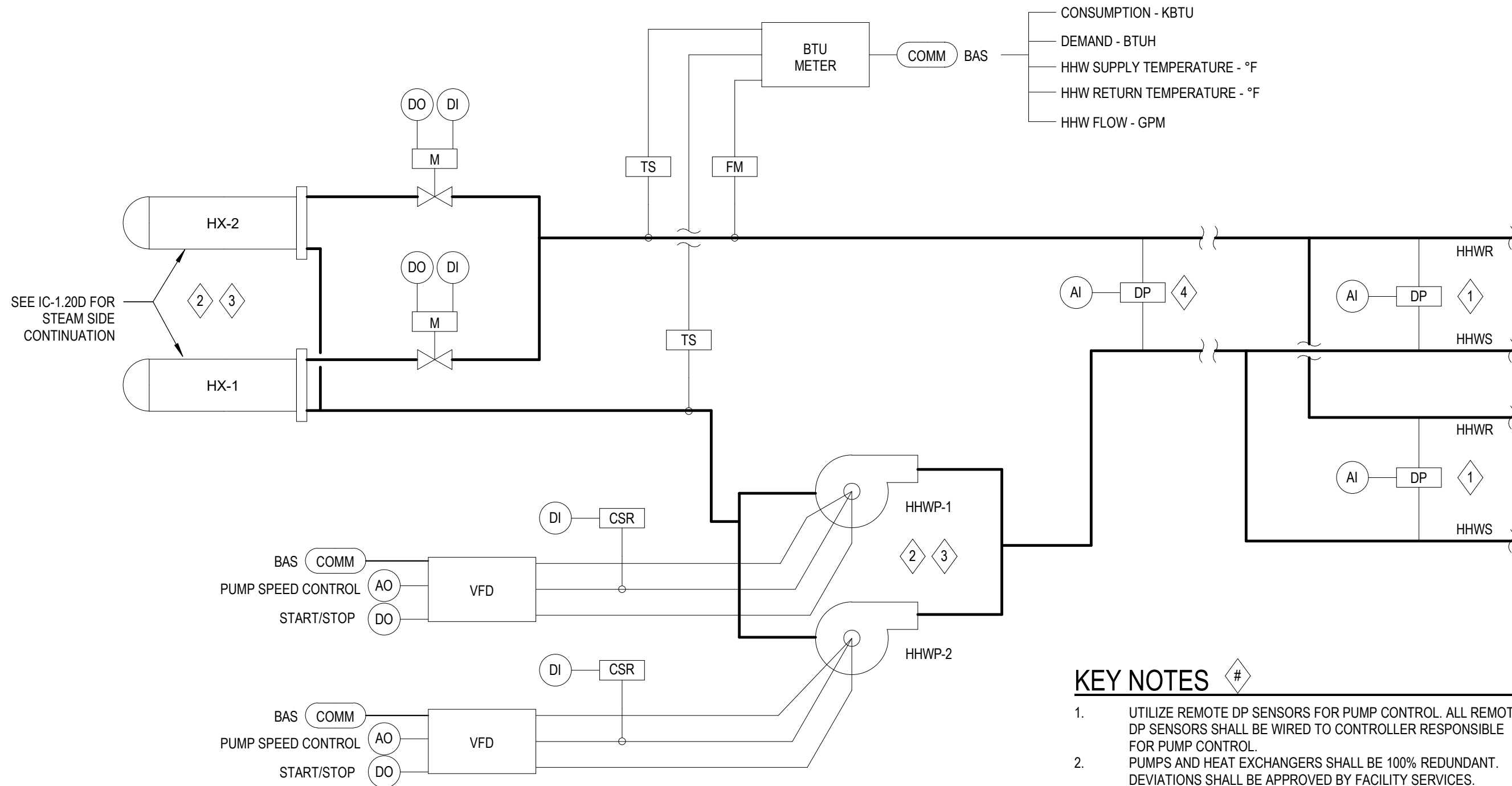

STEAM/HOT WATER REDUNDANT HEAT EXCHANGER CONTROL SEQUENCE GUIDELINE (IC-1.21S)

NOTES TO THE ENGINEER:

1. THIS SEQUENCE GUIDE IS INTENDED TO PROVIDE THE DESIGN PROFESSIONAL WITH A BASIC GUIDELINE OF MINIMUM REQUIREMENTS FOR A TYPICAL STEAM HEAT EXCHANGER CONTROL SYSTEM. ALL PROPOSED MODIFICATIONS SHALL BE REVIEWED WITH UF FACILITY SERVICES (FS).
2. THE INTENT IS FOR THIS SEQUENCE TO BE INCLUDED IN THE CONTRACT DRAWINGS ALONG WITH THE CONTROL DIAGRAMS.
3. REFERENCE STANDARD CONTROL DIAGRAMS IC-1.20D AND IC-1.21D.

PROVIDE THE FOLLOWING FOR HEAT EXCHANGER SYSTEM.

1. APPROPRIATE TEMPERATURE, FLOW AND PRESSURE SENSORS.
2. WATER SIDE BTU AND STEAM METERS
3. HEAT EXCHANGER ISOLATION VALVES
4. DIFFERENTIAL PRESSURE SENSORS FOR PUMP CONTROL
5. NORMALLY CLOSED- SPRING RETURN STEAM CONTROL VALVES
6. SYSTEM ENABLE/DISABLE SHALL BE DETERMINED BY BUILDING OCCUPANCY SCHEDULE AND AHU STATUS.

ENABLE MODE:

1. THE BAS SHALL ENABLE THE STEAM/HOT WATER HEAT EXCHANGER SYSTEM WHEN ANY AHU IS PROVEN ON.
2. ONCE THE SYSTEM IS ENABLED, OPEN THE LEAD EXCHANGER HOT WATER ISOLATION VALVE AND START THE HEATING HOT WATER PUMPS AND ENABLE DIFFERENTIAL PRESSURE CONTROL.
3. VERIFY PUMPS ARE RUNNING BY WAY OF PUMP STATUS AND WATER FLOW METER.
4. UPON VERIFICATION THAT PUMP(S) ARE ON AND WATER IS FLOWING THROUGH THE LEAD HEAT EXCHANGER, ENABLE THE HEAT EXCHANGER TEMPERATURE CONTROL SEQUENCE AND STEAM VALVE CONTROL.

HEAT EXCHANGER TEMPERATURE CONTROL (LEAD/STANDBY EACH HEAT EXCHANGER SIZED AT 100%):

1. SOFTWARE LEAD/STANDBY FUNCTION SHALL ALLOW EITHER OF THE HEAT EXCHANGERS TO ACT AS THE LEAD EXCHANGER.
2. PROVIDE TEMPERATURE SENSORS IN THE HEATING HOT WATER SUPPLY PIPING (EACH HEAT EXCHANGER) AND OUTDOOR AIR. INCLUDE A HEATING HOT WATER RESET STRATEGY TO OPTIMIZE HEATING HOT WATER SYSTEM.
3. ONCE THE TEMPERATURE SETPOINT HAS BEEN ESTABLISHED MODULATE THE LEAD EXCHANGER STEAM CONTROL VALVE AS NEEDED TO MAINTAIN HEATING HOT WATER SUPPLY SETPOINT.
4. THE BAS SHALL CONTINUE MONITORING THE SUPPLY WATER TEMPERATURE AND SETPOINT AT THE LEAD HEAT EXCHANGER. IN THE EVENT THE SUPPLY WATER TEMPERATURE DIFFERS FROM THE SUPPLY SETPOINT BY MORE THAN XXX DEG F (ADJ) FOR MORE THAN XXX MINUTES (ADJ), SET AN ALARM FOR THE LEAD HEAT EXCHANGER AND CLOSE THE LEAD EXCHANGER STEAM CONTROL VALVE AND HOT WATER ISOLATION VALVE. OPEN THE STANDBY EXCHANGER ISOLATION VALVE AND RE-ESTABLISH TEMPERATURE CONTROL USING THE STANDBY HEAT EXCHANGER STEAM CONTROL VALVES.
5. THE BAS SHALL LOCKOUT THE PRIMARY HEAT EXCHANGER UNTIL A MANUAL RESET IS INITIATED BY AN OPERATOR.
6. PRIMARY HEAT EXCHANGER DESIGNATION SHALL BE ROTATED WEEKLY (ADJ) IN ACCORDANCE WITH THE BAS SCHEDULE.

PUMP CONTROL (LEAD/STANDBY EACH PUMP SIZED AT 100%):

1. ONCE ENABLED THE PUMP SPEED SHALL BE MODULATED TO MAINTAIN THE CALCULATED DIFFERENTIAL PRESSURE SETPOINT.
2. SOFTWARE LEAD/STANDBY PUMP CONTROL FUNCTION SHALL ALLOW EITHER OF THE HEATING HOT WATER PUMPS TO ACT AS THE LEAD PUMP, WHILE DESIGNATING THE OTHER PUMP AS A STANDBY PUMP.
3. DIFFERENTIAL PRESSURE RESET CONTROL: THE BAS SHALL CONTINUOUSLY POLL THE VALVE POSITION OF ALL HEATING HOT WATER COILS. THE BAS SHALL RESET DIFFERENTIAL PRESSURE SET-POINT UP OR DOWN TO CONTINUALLY RESET THE SYSTEM DIFFERENTIAL PRESSURE SETPOINT FOR OPTIMUM PERFORMANCE. SPECIFIC PARAMETERS AND TESTING PARAMETERS SHALL BE ESTABLISHED BY EOR. WHEN TWO REMOTE DIFFERENTIAL PRESSURE SENSORS ARE USED, CONTROL TO THE SENSOR THAT IS FARTHEST FROM SETPOINT.
4. IN THE EVENT REMOTE DIFFERENTIAL PRESSURE SENSORS BECOME UNRELIABLE, UTILIZE LOCAL DIFFERENTIAL PRESSURE FOR PUMP CONTROL TAKING INTO CONSIDERATION THE ADJUSTED SETPOINT
5. ALARM ON PUMP FAILURE DETECTED VIA CURRENT SENSING SWITCH. UPON FAILURE OF THE LEAD PUMP, THE STANDBY PUMP SHALL START AUTOMATICALLY. THE BAS SHALL MAINTAIN A START COMMAND AT THE LEAD PUMP AND RESUME CONTROL WHEN THE LEAD PUMP HAS RETURNED TO NORMAL OPERATION.
6. LEAD PUMP DESIGNATION SHALL BE ROTATED WEEKLY (ADJ) IN ACCORDANCE WITH THE BAS SCHEDULE.

PUMP ROTATION: UPON SIGNAL FROM THE BAS TO ROTATE THE PUMPS, EXECUTE THE FOLLOWING SEQUENCE.

1. INITIATE ROTATION IN ACCORDANCE WITH A BAS SCHEDULE OR BY MANUAL INITIATION.
2. WHILE THE CURRENT LEAD PUMP IS STILL ACTIVE START THE STANDBY PUMP AND DESIGNATE AS THE NEW LEAD PUMP.
3. UPON PROOF OF NEW STANDBY PUMP RUNNING STATUS VIA CURRENT SENSING RELAY, COMMAND THE NEWLY DESIGNATED STANDBY PUMP TO OFF.
4. MAINTAIN DIFFERENTIAL PRESSURE CONTROL WITH THE NEW LEAD PUMP.

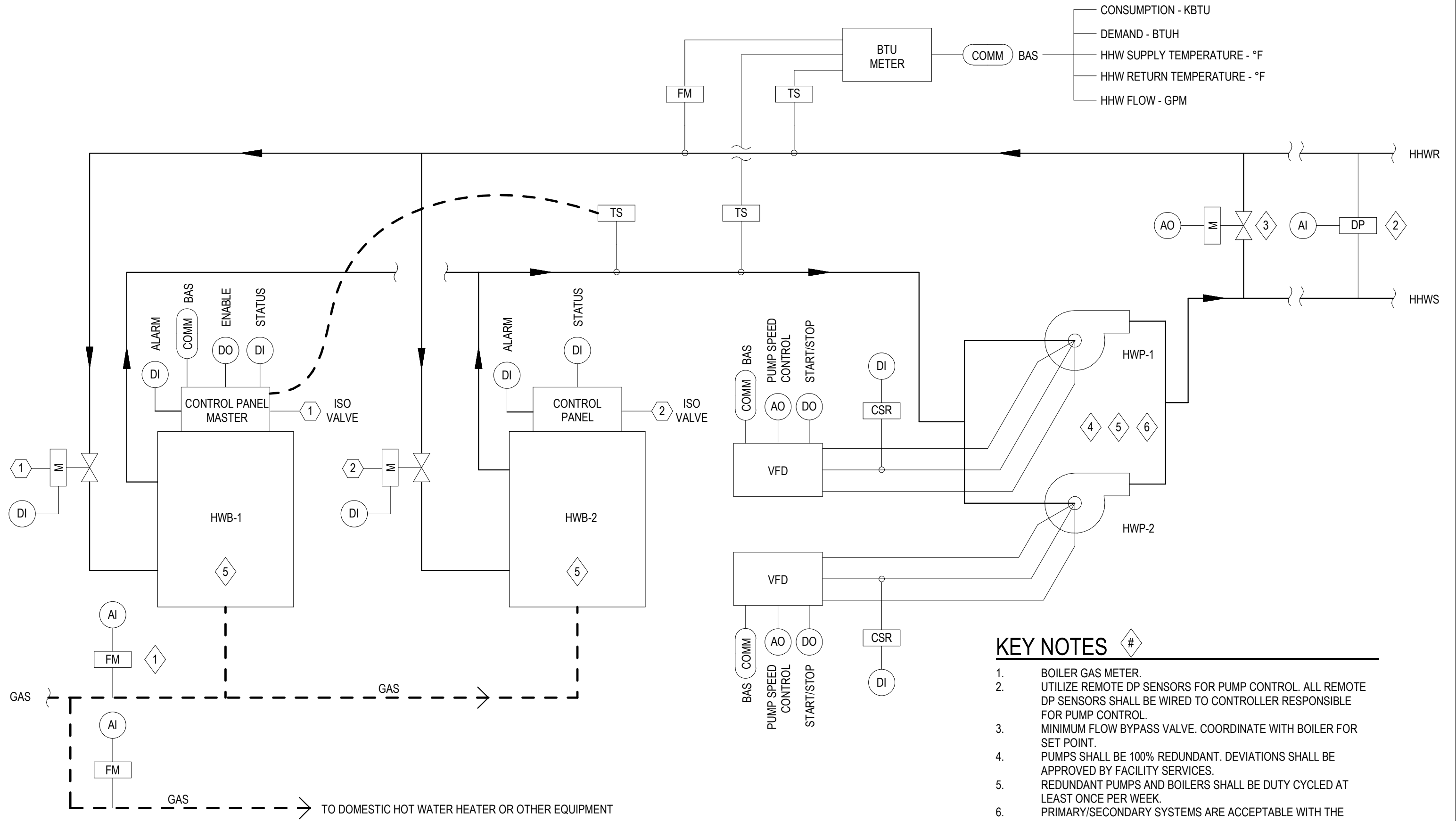

KEY NOTES #

1. BOILER GAS METER.
2. UTILIZE REMOTE DP SENSORS FOR PUMP CONTROL. ALL REMOTE DP SENSORS SHALL BE WIRED TO CONTROLLER RESPONSIBLE FOR PUMP CONTROL.
3. MINIMUM FLOW BYPASS VALVE. COORDINATE WITH BOILER FOR SET POINT.
4. PUMPS SHALL BE 100% REDUNDANT. DEVIATIONS SHALL BE APPROVED BY FACILITY SERVICES.
5. REDUNDANT PUMPS AND BOILERS SHALL BE DUTY CYCLED AT LEAST ONCE PER WEEK.
6. PRIMARY/SECONDARY SYSTEMS ARE ACCEPTABLE WITH THE APPROVAL OF FACILITY SERVICES.

HHW BOILER CONTROL SEQUENCE GUIDELINE (IC-1.22S)

NOTES TO THE ENGINEER:

1. THIS SEQUENCE GUIDE IS INTENDED TO PROVIDE THE DESIGN PROFESSIONAL WITH A BASIC GUIDELINE OF MINIMUM REQUIREMENTS FOR A TYPICAL HHW BOILER CONTROL SYSTEM. ALL PROPOSED MODIFICATIONS SHALL BE REVIEWED WITH UF FACILITY SERVICES (FS).
2. THE INTENT IS FOR THIS SEQUENCE TO BE INCLUDED IN THE CONTRACT DRAWINGS ALONG WITH THE CONTROL DIAGRAMS.
3. REFERENCE STANDARD CONTROL DIAGRAM IC-1.22D

PROVIDE THE FOLLOWING FOR HEATING HOT WATER SYSTEMS:

1. APPROPRIATE TEMPERATURE, FLOW AND PRESSURE SENSORS.
2. HOT WATER BTU METER AND WHEN APPLICABLE GAS METER
3. DIFFERENTIAL PRESSURE SENSORS FOR PUMP CONTROL
4. BOILER ISOLATION VALVES AND BOILER MANAGEMENT SYSTEMS
5. SYSTEM ENABLE/DISABLE SHALL BE DETERMINED BY BUILDING OCCUPANCY SCHEDULE AND AHU STATUS.

START-STOP SEQUENCE: UPON START-UP, ENABLE THE HHW PUMPING SYSTEM AND BOILERS. UPON SHUTDOWN, DISABLE ALL HHW PUMPING SYSTEMS AND DISABLE BOILERS. THIS SEQUENCE SHALL BE FUNCTIONAL FOR ANY REASON THE PUMP STARTS-STOPS IN ANY MODE OF OPERATION (ALL H-O-A MODES, ALL VFD MODES, ALL AUTOMATIC AND SAFETY FUNCTIONS, AND LOCAL MANUAL START-STOP).

PUMP CONTROL (LEAD/STANDBY EACH PUMP SIZED AT 100%):

1. ONCE ENABLED THE PUMP SPEED SHALL BE MODULATED TO MAINTAIN THE CALCULATED DIFFERENTIAL PRESSURE SETPOINT.
2. SOFTWARE LEAD/STANDBY PUMP CONTROL FUNCTION SHALL ALLOW EITHER OF THE HHW WATER PUMPS TO ACT AS THE LEAD PUMP, WHILE DESIGNATING THE OTHER PUMP AS A STANDBY PUMP.
3. DIFFERENTIAL PRESSURE RESET CONTROL: THE BAS SHALL CONTINUOUSLY POLL THE VALVE POSITION OF ALL HEATING HOT WATER COILS. THE BAS SHALL RESET DIFFERENTIAL PRESSURE SET-POINT UP OR DOWN TO CONTINUALLY RESET THE SYSTEM DIFFERENTIAL PRESSURE SETPOINT FOR OPTIMUM PERFORMANCE. SPECIFIC PARAMETERS AND TESTING PARAMETERS SHALL BE ESTABLISHED BY EOR. WHEN TWO REMOTE DIFFERENTIAL PRESSURE SENSORS ARE USED, CONTROL TO THE SENSOR THAT IS FARTHEST FROM SETPOINT.
4. IN THE EVENT REMOTE DIFFERENTIAL PRESSURE SENSORS BECOME UNRELIABLE, UTILIZE LOCAL DIFFERENTIAL PRESSURE FOR PUMP CONTROL TAKING INTO CONSIDERATION THE ADJUSTED SETPOINT
5. ALARM ON PUMP FAILURE DETECTED VIA CURRENT SENSING SWITCH. UPON FAILURE OF THE LEAD PUMP, THE STANDBY PUMP SHALL START AUTOMATICALLY. THE BAS SHALL MAINTAIN A START COMMAND AT THE LEAD PUMP AND RESUME CONTROL WHEN THE LEAD PUMP HAS RETURNED TO NORMAL OPERATION.
6. LEAD PUMP DESIGNATION SHALL BE ROTATED WEEKLY (ADJ) IN ACCORDANCE WITH THE BAS SCHEDULE.

PUMP ROTATION: UPON SIGNAL FROM THE BAS TO ROTATE THE PUMPS, EXECUTE THE FOLLOWING SEQUENCE.

1. INITIATE ROTATION IN ACCORDANCE WITH A BAS SCHEDULE OR BY MANUAL INITIATION.
2. WHILE THE CURRENT LEAD PUMP IS STILL ACTIVE START THE STANDBY PUMP AND DESIGNATE AS THE NEW LEAD PUMP.
3. UPON PROOF OF NEW STANDBY PUMP RUNNING STATUS VIA CURRENT SENSING RELAY, COMMAND THE NEWLY DESIGNATED STANDBY PUMP TO OFF.
4. MAINTAIN DIFFERENTIAL PRESSURE CONTROL WITH THE NEW LEAD PUMP.

BOILER CONTROL: UPON SIGNAL FROM THE BAS TO RUN THE BOILER SYSTEM SHALL START.

1. THE BAS SHALL SEND AN ENABLE COMMAND TO THE BOILER CONTROL SYSTEM.
2. THE BOILER CONTROL SYSTEM SHALL DETERMINE THE OPTIMUM RUN CONDITION OF ALL BOILERS AND MAINTAIN THE HEATING HOT WATER SUPPLY TEMPERATURE SETPOINT.
3. BOILER ISOLATION VALVES SHALL BE INTERLOCKED WITH THE BOILER TO OPEN ONLY WHEN THE BOILER IS ACTIVE.

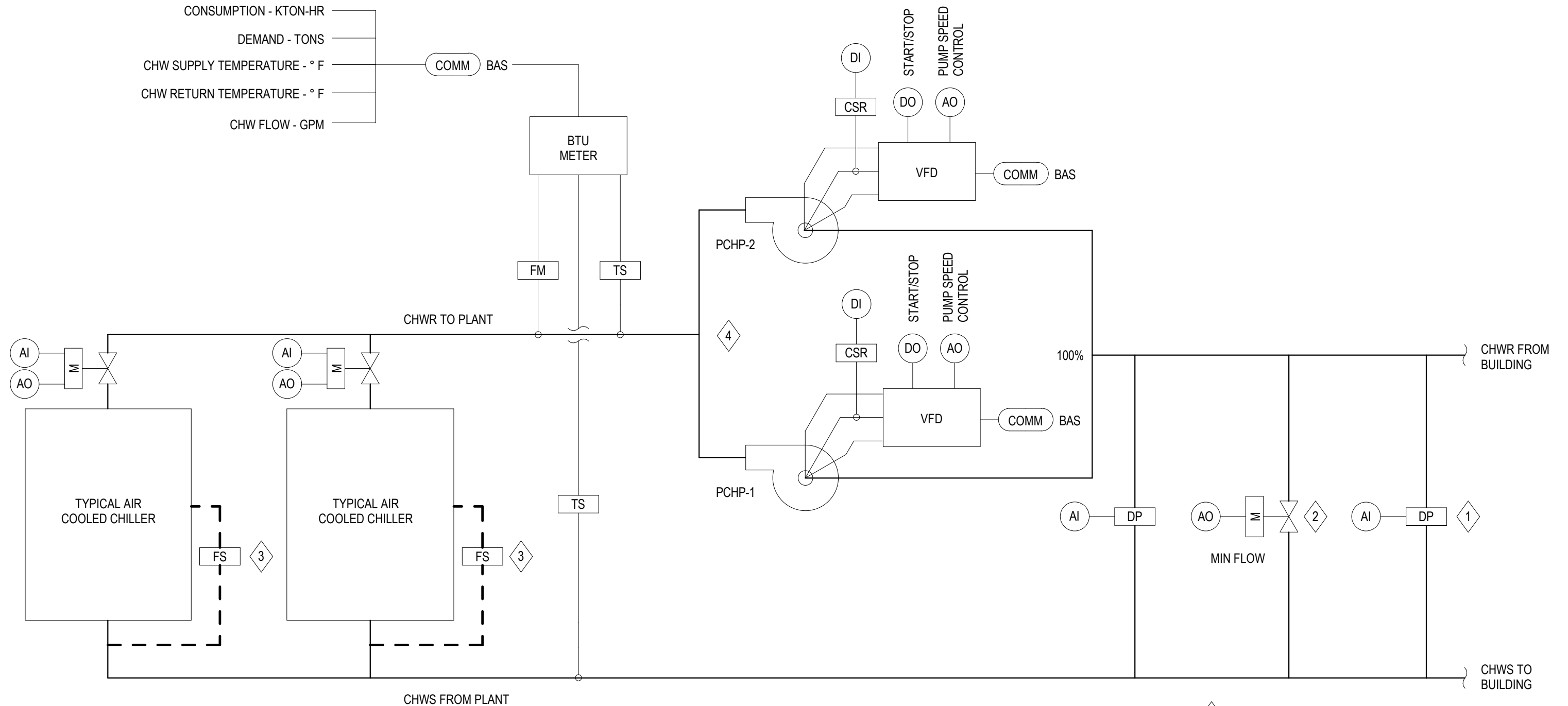

KEY NOTES

1. UTILIZE REMOTE DP SENSOR FOR PUMP CONTROL. ALL REMOTE DP SENSORS SHALL BE WIRED TO CONTROLLER RESPONSIBLE FOR PUMP CONTROL.
2. MINIMUM FLOW BYPASS VALVE. COORDINATE WITH CHILLER MANUFACTURER FOR SETPOINT.
3. FLOW SWITCH HARDWIRED TO CHILLER.
4. PRIMARY/SECONDARY SYSTEMS ARE ACCEPTABLE WITH THE APPROVAL OF FACILITY SERVICES.

AIR COOLED CHILLER CONTROL SEQUENCE GUIDELINE (IC-1.23S)

NOTES TO THE ENGINEER:

1. THIS SEQUENCE GUIDE IS INTENDED TO PROVIDE THE DESIGN PROFESSIONAL WITH A BASIC GUIDELINE OF MINIMUM REQUIREMENTS FOR A TYPICAL AIR COOLED CHILLED WATER SYSTEM. ALL PROPOSED MODIFICATIONS SHALL BE REVIEWED WITH UF FACILITY SERVICES (FS).
2. THE INTENT IS FOR THIS SEQUENCE TO BE INCLUDED IN THE CONTRACT DRAWINGS ALONG WITH THE CONTROL DIAGRAMS.
3. REFERENCE STANDARD CONTROL DIAGRAM IC-1.23D

PROVIDE THE FOLLOWING FOR CHILLED WATER PUMPING SYSTEMS:

1. APPROPRIATE SENSORS TO ACHIEVE SEQUENCE OF OPERATION.
2. DIFFERENTIAL PRESSURE SENSORS FOR PUMP CONTROL
3. SYSTEM ENABLE/DISABLE SHALL BE DETERMINED BY BUILDING OCCUPANCY SCHEDULE AND AHU STATUS.

START-STOP SEQUENCE: UPON START-UP, ENABLE THE CHILLED WATER PUMPING SYSTEM AND CHILLERS. UPON SHUTDOWN, DISABLE ALL CHILLED WATER PUMPING SYSTEMS AND DISABLE CHILLERS. THIS SEQUENCE SHALL BE FUNCTIONAL FOR ANY REASON THE PUMP STARTS- STOPS IN ANY MODE OF OPERATION (ALL H-O-A MODES, ALL VFD MODES, ALL AUTOMATIC AND SAFETY FUNCTIONS, AND LOCAL MANUAL START-STOP).

PUMP CONTROL (LEAD/STANDBY EACH PUMP SIZED AT 100%):

1. ONCE ENABLED THE PUMP SPEED SHALL BE MODULATED TO MAINTAIN THE CALCULATED DIFFERENTIAL PRESSURE SETPOINT.
2. SOFTWARE LEAD/STANDBY PUMP CONTROL FUNCTION SHALL ALLOW EITHER OF THE CHILLED WATER PUMPS TO ACT AS THE LEAD PUMP, WHILE DESIGNATING THE OTHER PUMP AS A STANDBY PUMP.
3. DIFFERENTIAL PRESSURE RESET CONTROL: THE BAS SHALL CONTINUOUSLY POLL THE VALVE POSITION OF ALL CHILLED WATER COILS. THE BAS SHALL RESET DIFFERENTIAL PRESSURE SET-POINT UP OR DOWN TO CONTINUALLY RESET THE SYSTEM DIFFERENTIAL PRESSURE SETPOINT FOR OPTIMUM PERFORMANCE. SPECIFIC PARAMETERS AND TESTING PARAMETERS SHALL BE ESTABLISHED BY EOR. WHEN TWO REMOTE DIFFERENTIAL PRESSURE SENSORS ARE USED, CONTROL TO THE SENSOR THAT IS FARTHEST FROM SETPOINT.
4. IN THE EVENT REMOTE DIFFERENTIAL PRESSURE SENSORS BECOME UNRELIABLE, UTILIZE LOCAL DIFFERENTIAL PRESSURE FOR PUMP CONTROL TAKING INTO CONSIDERATION THE ADJUSTED SETPOINT
5. MAINTAIN MINIMUM FLOW WITH BYPASS VALVE
6. ALARM ON PUMP FAILURE DETECTED VIA CURRENT SENSING SWITCH. UPON FAILURE OF THE LEAD PUMP, THE STANDBY PUMP SHALL START AUTOMATICALLY. THE BAS SHALL MAINTAIN A START COMMAND AT THE LEAD PUMP AND RESUME CONTROL WHEN THE LEAD PUMP HAS RETURNED TO NORMAL OPERATION.
7. LEAD PUMP DESIGNATION SHALL BE ROTATED WEEKLY (ADJ) IN ACCORDANCE WITH THE BAS SCHEDULE.

PUMP ROTATION: UPON SIGNAL FROM THE BAS TO ROTATE THE PUMPS, EXECUTE THE FOLLOWING SEQUENCE.

1. INITIATE ROTATION IN ACCORDANCE WITH A BAS SCHEDULE OR BY MANUAL INITIATION.
2. WHILE THE CURRENT LEAD PUMP IS STILL ACTIVE START THE STANDBY PUMP AND DESIGNATE AS THE NEW LEAD PUMP.
3. UPON PROOF OF NEW STANDBY PUMP RUNNING STATUS VIA CURRENT SENSING RELAY, COMMAND THE NEWLY DESIGNATED STANDBY PUMP TO OFF.
4. MAINTAIN DIFFERENTIAL PRESSURE CONTROL WITH THE NEW LEAD PUMP.

PROVIDE THE FOLLOWING FOR CHILLER SYSTEM:

CHILLER CONTROL: THE CHILLED WATER SUPPLY TEMPERATURE SET POINT IS SET TO THE CHILLER PLANT DESIGN TEMPERATURE AND CAN BE MANUALLY ADJUSTED UPWARD BY THE OPERATOR.

THE CHILLED WATER SYSTEM ENABLE POINT SHALL BE CONTROLLED EITHER MANUALLY BY THE OPERATOR OR BY A PROGRAM FUNCTION (I.E., TIME-OF-DAY). IF THE SYSTEM ENABLE POINT IS ON AND THERE IS A CALL FOR COOLING (EOR TO DETERMINE ACTIVATION CONDITIONS).

THE CHILLER START SEQUENCE FIRST OPENS ISOLATION VALVE, THEN STARTS THE CHILLED WATER PUMPS. AFTER A TIME DELAY, THE CHILLER START/STOP POINT SHALL TURN ON. AFTER FLOW IS PROVEN, THE CHILLER OPERATES UNDER ITS LOCAL SETPOINTS AND SAFETY CONTROLS.

AFTER ANY CHILLER(S) ARE COMMANDED, THE PROGRAM SHALL WAIT FOR 15 MINUTES (ADJ) BEFORE ISSUING ANY OTHER COMMANDS.

THE CHILLER STOP SEQUENCE FIRST STOPS THE CHILLER. AFTER A TIME DELAY, CHILLED WATER PUMP IS STOPPED, THEN ISOLATION VALVE IS CLOSED.

CHILLER STAGING SHALL BE IN DIRECT RESPONSE TO LOAD. EOR TO DETERMINE OPTIMUM LEAD LAG SEQUENCE TO ENSURE OPTIMUM EFFICIENCY OF SYSTEM.

CHILLER ISOLATION VALVES SHALL BE OPENED ONLY WHEN THE ASSOCIATED CHILLER IS ACTIVATED.

THE CHILLED WATER SYSTEM SHALL CONTINUE TO OPERATE UNTIL EITHER THE CHILLED WATER SYSTEM ENABLE POINT IS OFF OR COOLING IS NO LONGER REQUIRED (INDICATED BY ALL AHUs BEING OFF OR ALL COOLING COIL VALVES BEING CLOSED FOR A 30 MINUTE TIME INTERVAL). UPON RECEIVING AN ALARM FROM LEAD CHILLER, THE BAS SHALL AUTOMATICALLY START THE LAG CHILLER AND HOLD UNTIL LEAD CHILLER IS RESET BY OPERATOR. THE PROGRAM SHALL INCLUDE AN "OUT OF SERVICE" MODE FOR BOTH CHILLERS TO ALLOW THE OPERATOR TO TAKE A CHILLER OFFLINE FOR MAINTENANCE.

KEY NOTES

1. UTILIZE REMOTE DP SENSORS FOR PUMP CONTROL. ALL REMOTE DP SENSORS SHALL BE WIRED TO CONTROLLER RESPONSIBLE FOR PUMP CONTROL.
2. PUMPS SHALL BE 100% REDUNDANT. DEVIATION SHALL BE APPROVED BY FACILITY SERVICES.
3. REDUNDANT PUMPS SHALL BE DUTY CYCLED AT LEAST ONCE PER WEEK.
4. OTHER PUMPING SCHEMES MAY BE ACCEPTABLE WITH APPROVAL BY FACILITY SERVICES.

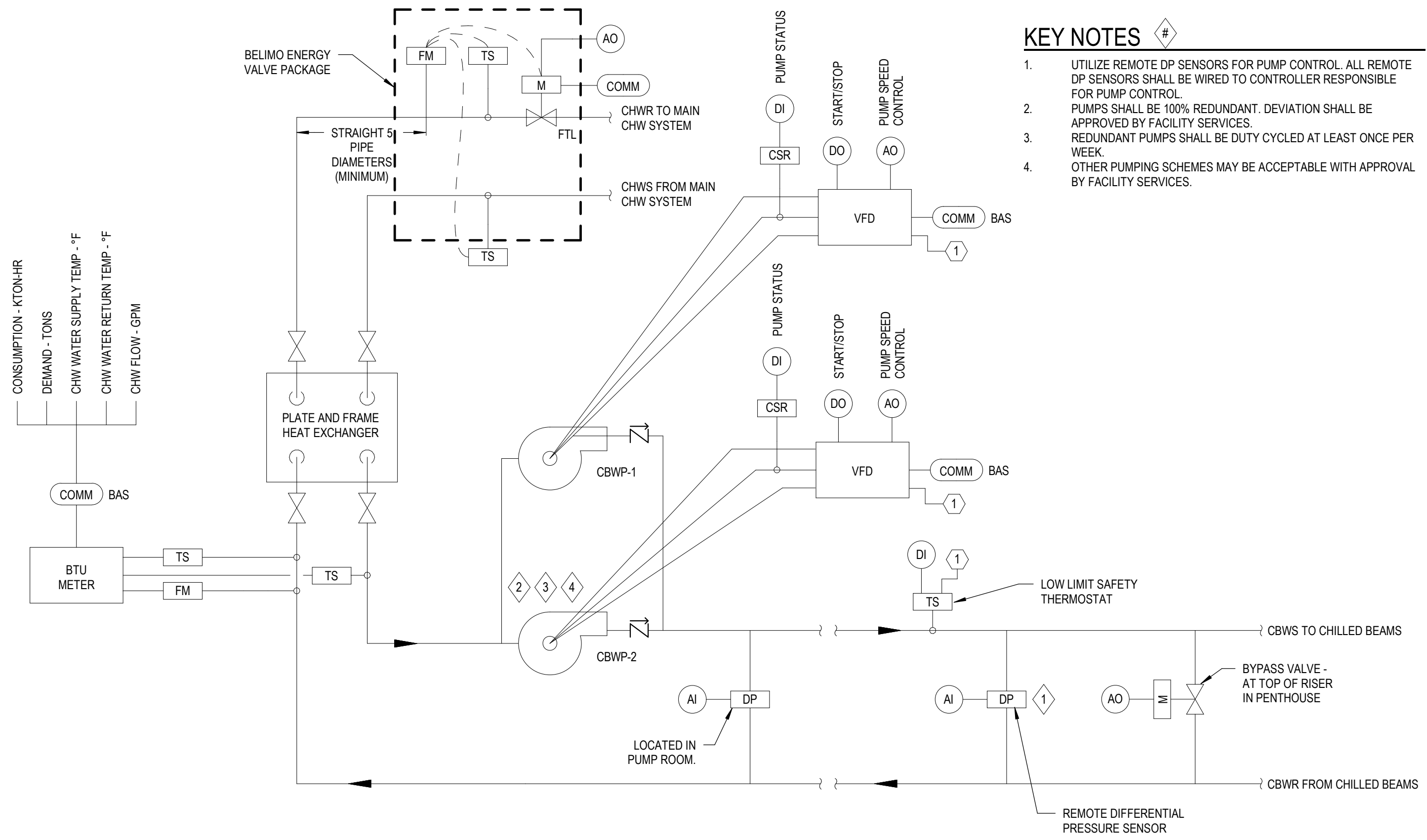

CHILLED BEAM WATER SUPPLY CONTROL SEQUENCE GUIDELINE (IC-1.24S)

NOTES TO THE ENGINEER:

1. THIS SEQUENCE GUIDE IS INTENDED TO PROVIDE THE DESIGN PROFESSIONAL WITH A BASIC GUIDELINE OF MINIMUM REQUIREMENTS FOR A TYPICAL CHILLED BEAM WATER SUPPLY CONTROL SYSTEM. ALL PROPOSED MODIFICATIONS SHALL BE REVIEWED WITH UF FACILITY SERVICES (FS).
2. THE INTENT IS FOR THIS SEQUENCE TO BE INCLUDED IN THE CONTRACT DRAWINGS ALONG WITH THE CONTROL DIAGRAMS.
3. REFERENCE STANDARD CONTROL DIAGRAM IC-1.24D

PROVIDE THE FOLLOWING FOR PROCESS WATER PUMPING SYSTEMS:

1. APPROPRIATE TEMPERATURE, FLOW AND PRESSURE SENSORS.
2. BYPASS VALVE FOR PRESSURE RELIEF.
3. SYSTEM ENABLE/DISABLE SHALL BE DETERMINED BY BAS OR LOCAL SWITCH.
4. LOW LIMIT SAFETY THERMOSTAT
5. PUMPING PACKAGE CONTROL
6. HEAT EXCHANGER CONTROL

START-STOP SEQUENCE: UPON START-UP, ENABLE THE PRIMARY PUMP CONTROL AND TEMPERATURE CONTROL. UPON SHUTDOWN, DISABLE ALL PUMPS, CLOSE CHILLED WATER VALVE AND OPEN BYPASS VALVE. THIS SEQUENCE SHALL BE FUNCTIONAL FOR ANY REASON THE PUMP STARTS-STOPS IN ANY MODE OF OPERATION (ALL H-O-A MODES, ALL VFD MODES, ALL AUTOMATIC AND SAFETY FUNCTIONS, AND LOCAL MANUAL START-STOP).

ENABLE MODE:

1. THE BAS SHALL ENABLE THE CHILLED BEAM WATER PUMPING SYSTEM AND HEAT EXCHANGER UPON PROOF OF PUMP FLOW.
2. BYPASS VALVE SHALL START IN THE FULL BYPASS POSITION.
3. VERIFY PUMPS ARE RUNNING BY WAY OF PUMP STATUS AND WATER FLOW METER.
4. UPON VERIFICATION THAT PUMP(S) ARE ON AND WATER IS FLOWING, ENABLE THE PUMP CONTROL SEQUENCE AND HEAT EXCHANGER CONTROL SEQUENCE.

PUMP CONTROL (LEAD/STANDBY EACH PUMP SIZED AT 100%):

1. ONCE ENABLED THE PUMP SPEED SHALL BE MODULATED TO MAINTAIN THE CALCULATED DIFFERENTIAL PRESSURE SETPOINT.
2. SOFTWARE LEAD/STANDBY PUMP CONTROL FUNCTION SHALL ALLOW EITHER OF THE CHILLED WATER PUMPS TO ACT AS THE LEAD PUMP, WHILE DESIGNATING THE OTHER PUMP AS A STANDBY PUMP.
3. MODULATE PUMP SPEED TO MAINTAIN DIFFERENTIAL PRESSURE SETPOINT.
4. UPON AN INCREASE IN DIFFERENTIAL PRESSURE AND AFTER THE PUMP HAS REACHED ITS MINIMUM SPEED, MODULATE THE BYPASS VALVE TO MAINTAIN DP SETPOINT.
5. ALARM ON PUMP FAILURE DETECTED VIA CURRENT SENSING SWITCH. UPON FAILURE OF THE LEAD PUMP, THE STANDBY PUMP SHALL START AUTOMATICALLY. THE BAS SHALL MAINTAIN A START COMMAND AT THE LEAD PUMP AND RESUME CONTROL WHEN THE LEAD PUMP HAS RETURNED TO NORMAL OPERATION.
6. LEAD PUMP DESIGNATION SHALL BE ROTATED WEEKLY (ADJ) IN ACCORDANCE WITH THE BAS SCHEDULE.

PUMP ROTATION: UPON SIGNAL FROM THE BAS TO ROTATE THE PUMPS, EXECUTE THE FOLLOWING SEQUENCE.

1. INITIATE ROTATION IN ACCORDANCE WITH A BAS SCHEDULE OR BY MANUAL INITIATION.
2. WHILE THE CURRENT LEAD PUMP IS STILL ACTIVE START THE STANDBY PUMP AND DESIGNATE AS THE NEW LEAD PUMP.
3. UPON PROOF OF NEW STANDBY PUMP RUNNING STATUS VIA CURRENT SENSING RELAY, COMMAND THE NEWLY DESIGNATED STANDBY PUMP TO OFF.
4. MAINTAIN DIFFERENTIAL PRESSURE CONTROL WITH THE NEW LEAD PUMP.

HX CONTROL

1. ONCE FLOW HAS BEEN VERIFIED ON THE MEDIUM TEMPERATURE CHILLED BEAM SIDE, ENABLE THE HEAT EXCHANGER CHILLED WATER VALVE CONTROL.
2. MODULATE THE HX CONTROL VALVE TO MAINTAIN THE CHILLED BEAM SUPPLY WATER LEAVING TEMPERATURE SETPOINT.

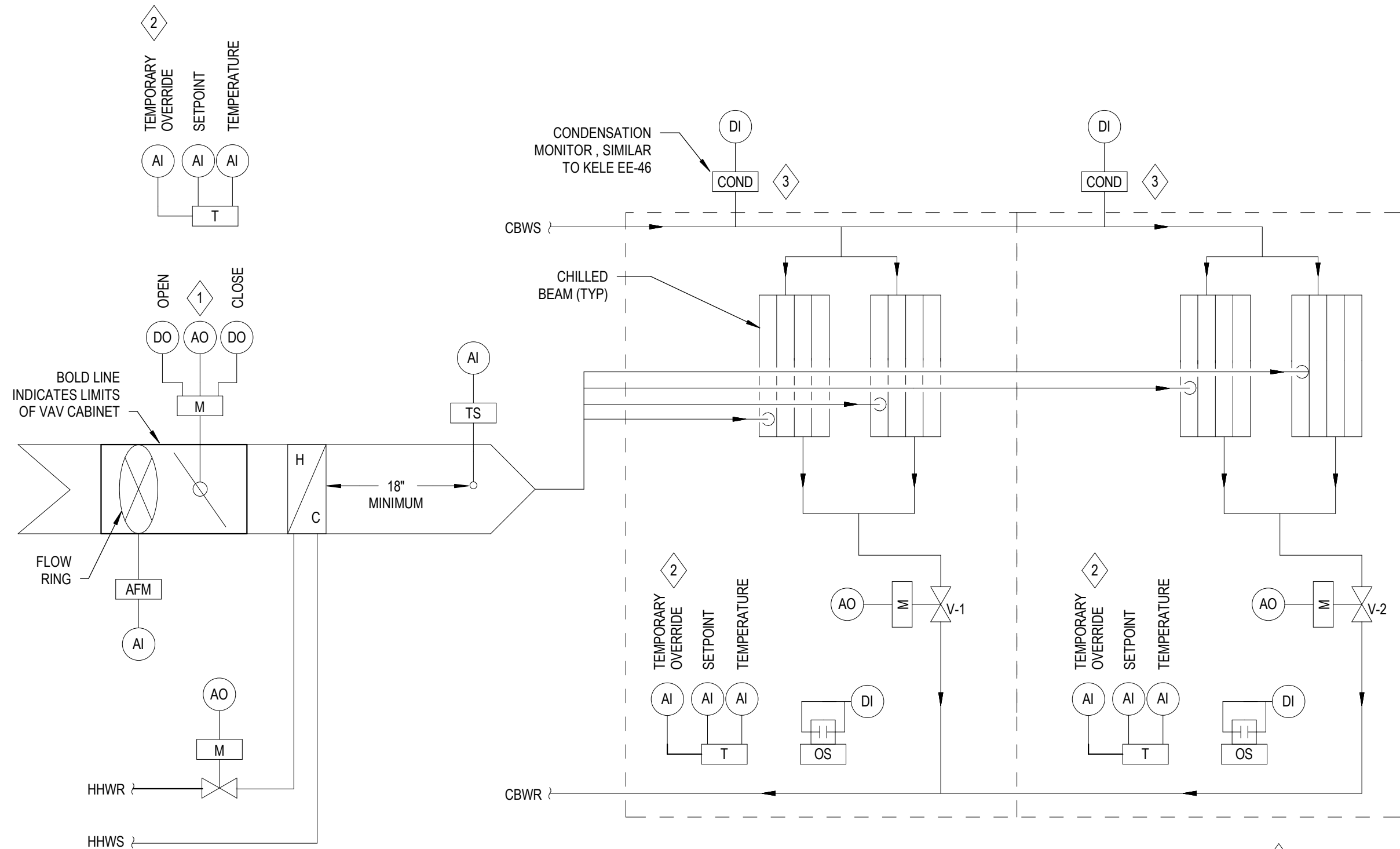

KEY NOTES #

1. EITHER ANALOG OR DIGITAL (FLOATING) CONTROL IS ACCEPTABLE.
2. INCLUDE TEMPORARY OVERRIDE CAPABILITY BUT DISABLE AND USE OCCUPANCY SENSOR WHEN POSSIBLE.
3. CONDENSATION SENSOR PER ZONE IF APPROVED BY FACILITY SERVICES.

CHILLED BEAM CONTROL SEQUENCE GUIDELINE (IC-1.25S)

NOTES TO THE ENGINEER:

1. THIS SEQUENCE GUIDE IS INTENDED TO PROVIDE THE DESIGN PROFESSIONAL WITH A BASIC GUIDELINE OF MINIMUM REQUIREMENTS FOR A TYPICAL CHILLED BEAM CONTROL. ALL PROPOSED MODIFICATIONS SHALL BE REVIEWED WITH UF FACILITY SERVICES (FS).
2. THE INTENT IS FOR THIS SEQUENCE TO BE INCLUDED IN THE CONTRACT DRAWINGS ALONG WITH THE CONTROL DIAGRAMS.
3. REFERENCE STANDARD CONTROL DIAGRAM IC-1.25D
4. NOTE: THIS SEQUENCE GUIDELINE IS OFFERED FOR ONE TYPICAL ACTIVE BEAM SYSTEM CONFIGURATION. PASSIVE BEAMS ARE NOT PERMITTED.

PROVIDE THE FOLLOWING FOR CHILLED BEAMS.

1. ROOM THERMOSTAT WITH INTEGRAL TEMPERATURE SENSOR, INTEGRAL DISPLAY, SLIDING SCALE SETPOINT ADJUSTMENT, AND REMOVE COMMUNICATION PORT.
2. SPACE HUMIDITY SENSOR.
3. VENTILATION TERMINAL UNIT WITH REHEAT
4. CHILLED BEAM WATER (CBW) CONTROL VALVE.
5. CONDENSATION SENSOR MOUNTED ON CBW SUPPLY PIPING.
6. OCCUPIED MODE AS DETERMINED BY THE SCHEDULE.

SAFETY CONTROL SEQUENCES: PROVIDE THE FOLLOWING SAFETY FUNCTIONS.

1. CONDENSATE ALARM: UPON DETECTION OF CONDENSATION ON THE SUPPLY PIPE, THE ASSOCIATED CHILLED BEAM CONTROL VALVE SHALL CLOSE AND ALARM AT THE BAS. CHILLED BEAM CONTROL VALVE SHALL REMAIN CLOSED AND IN ALARM UNTIL CONDENSATION IS NO LONGER DETECTED.

OCCUPIED MODE:

1. THE CONTROLLER SHALL CONTINUE TO MONITOR ROOM TEMPERATURE AND MODULATE THE CBW CONTROL VALVE OUTPUT IN RESPONSE TO COOLING/HEATING DEMAND.
2. ON A RISE IN ROOM TEMPERATURE ABOVE OCCUPIED COOLING SETPOINT AND UPON PROOF THAT ASSOCIATED VENTILATION TERMINAL BOX HEAT IS DISENGAGED, MODULATE THE CHILLED BEAM CONTROL VALVE OPEN UNTIL OCCUPIED COOLING SETPOINT IS SATISFIED.
3. ON A FALL IN ROOM TEMPERATURE BELOW OCCUPIED HEATING SETPOINT, MODULATE THE CHILLED BEAM CONTROL VALVE CLOSED.
4. ON A CONTINUED FALL IN ROOM TEMPERATURE, INCREASE THE HEATING OUTPUT TO MAINTAIN HEATING SETPOINT FOR THE VENTILATION ZONE

UNOCCUPIED MODE 1 (ASSOCIATED AHU IS SCHEDULED OFF):

1. THE CONTROL AIR DAMPER SHALL REMAIN AT ITS MINIMUM POSITION (25% OPEN).
2. IN THE EVENT THE AHU IS ENABLED DURING UNOCCUPIED HOURS (DUE TO A HIGH ZONE TEMPERATURE), THE BOX SHALL CONTROL ACCORDING TO THE OCCUPIED MODE DESCRIBED ABOVE BUT USING THE UNOCCUPIED SETPOINTS.
3. UPON ACTIVATION OF THE AHU BASED ON OCCUPANCY SENSORS, THE ASSOCIATED AHU SHALL BE TEMPORARILY ACTIVATED AND THE CHILLED BEAM SYSTEM SHALL RESUME NORMAL OCCUPANCY MODE CONTROL. DEACTIVATION OF ALL LOCAL OCCUPANCY SENSORS SHALL RETURN THE CHILLED BEAM SYSTEM TO ITS UNOCCUPIED STATE AND CAUSE THE ASSOCIATED AHU TO SHUT DOWN.
4. CHILLED BEAM AND ASSOCIATED AHU SHALL REMAIN OCCUPIED AND ACTIVE FOR A MINIMUM OF 1 HR (ADJ) ONCE ACTIVATED

UNOCCUPIED MODE 2 (ASSOCIATED AHU IS SCHEDULED ON AND OCCUPANCY SENSOR IS OFF):

1. THE CHILLED BEAM SYSTEM SHALL CONTINUE TO FUNCTION AS DESCRIBED UNDER OCCUPIED MODE WITH THE FOLLOWING ADJUSTMENTS.
2. THE MINIMUM CFM SETPOINT SHALL BE RESET TO XXX% OF THE DESIGN NORMAL MINIMUM.
3. COOLING AND HEATING UNOCCUPIED SETPOINTS SHALL BE ACTIVE.

KEY NOTES

1. CALCULATE ENTHALPY USING HUMIDITY/TEMPERATURE SENSOR.
2. START WHEEL AT LOW SPEED TO PREVENT PREMATURE FAILURE OF WHEEL MOTOR.

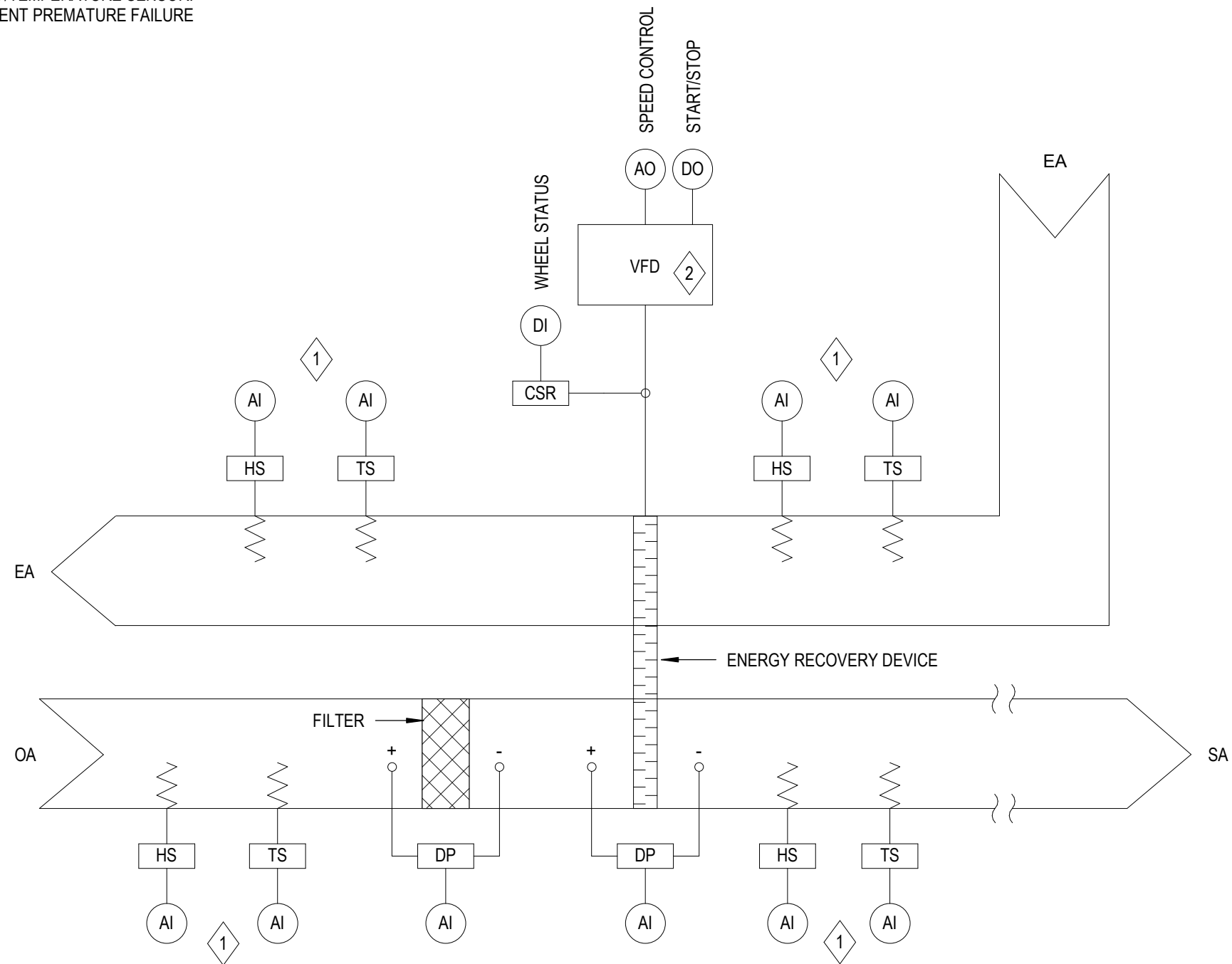

MIXED AIR AHU CONTROL SEQUENCE GUIDELINE (IC-1.25S)

NOTES TO THE ENGINEER:

1. THIS SEQUENCE GUIDE IS INTENDED TO PROVIDE THE DESIGN PROFESSIONAL WITH A BASIC GUIDELINE OF MINIMUM REQUIREMENTS FOR A TYPICAL MIXED AIR CONTROL. ALL PROPOSED MODIFICATIONS SHALL BE REVIEWED WITH UF FACILITY SERVICES (FS).
2. THE INTENT IS FOR THIS SEQUENCE TO BE INCLUDED IN THE CONTRACT DRAWINGS ALONG WITH THE CONTROL DIAGRAMS.
3. REFERENCE STANDARD CONTROL DIAGRAM IC-1.26D

PROVIDE THE FOLLOWING FOR ENERGY RECOVERY WHEEL.

1. ENERGY RECOVERY WHEEL WITH VFD
2. OUTSIDE AIR UPSTREAM FILTER

START-STOP SEQUENCES: PROVIDE THE FOLLOWING OPERATIONAL FUNCTIONS WHEN THE AIR HANDLING UNIT FAN IS STARTED OR STOPPED. THESE SEQUENCES SHALL BE OPERATIONAL UPON PROOF OF FAN STATUS REGARDLESS OF MODE (HAND, OFF, AUTO, OR BYPASS)

1. ENABLE ENERGY RECOVERY CONTROL UPON PROOF OF FAN STATUS

WHEN THE UNIT IS PROVEN ON IN RESPONSE TO THE BAS OR A MANUAL OVERRIDE, PROVIDE THE FOLLOWING.

ENERGY RECOVERY WHEEL CONTROL:

SPEED CONTROL: IN GENERAL, THE ENERGY RECOVERY WHEEL SHALL MODULATE TO MAINTAIN THE WHEEL SUPPLY TEMPERATURE SETPOINT IN WINTER MODE, STOPS IN ECONOMIZER MODE, AND ROTATES AT A CONSTANT 20 RPM IN SUMMER MODE.

SUMMER MODE: IF THE OUTDOOR TEMPERATURE IS GREATER THAN RETURN TEMPERATURE BY 5 DEG F (ADJ), THE MODE IS SUMMER AND THE WHEEL SPEED SHALL BE 20 RPM.

WINTER MODE: IF THE OUTDOOR TEMPERATURE IS LESS THAN RETURN TEMPERATURE BY 20 DEG F (ADJ), THE WHEEL IS IN WINTER MODE AND THE WHEEL MODULATES TO MAINTAIN THE SUPPLY TEMPERATURE SETPOINT OF 52 DEG F (ADJ).

ECONOMIZER MODE: IF THE OUTDOOR TEMPERATURE IS LESS THAN THE EXHAUST TEMPERATURE AND THE OUTDOOR AIR TEMPERATURE IS GREATER THAN 55 DEG F (ADJ), THE WHEEL IS IN ECONOMIZER MODE. THE VFD RECEIVES A 0% DEMAND SIGNAL, AND THE WHEEL SHALL STOP.

